

# **MFC** **MOTOCROSS** **CENTER.COM**

BETA RR 200 MY 2021

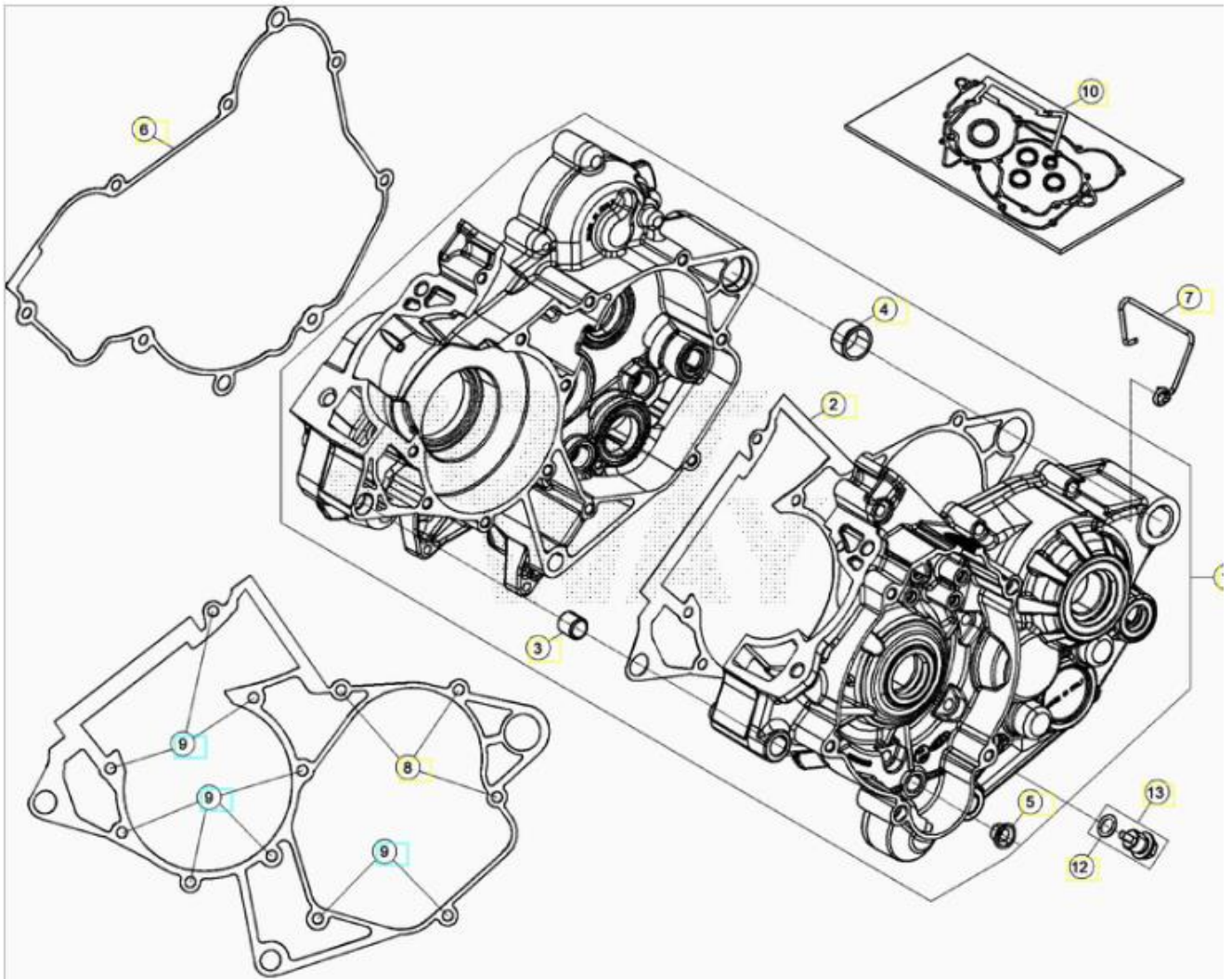



REF. NO.	PART NO.	CRANKCASE DESCRIPTION	200 RR 2T	
<input type="checkbox"/>	1	035.010328.000	CRANKCASE ASSY	1
<input type="checkbox"/>	2	035.010330.000	CRANKCASE GASKET	1
<input type="checkbox"/>	3	16.41500.000	DOWEL 10,5.13.13	1
<input type="checkbox"/>	4	006.010120.000	BUSH (BACK) 17.21.12	1
<input type="checkbox"/>	5	C03020010000	BUSH 8X10X8	1
<input type="checkbox"/>	6	035.010090.000	CLUTCH COVER GASKET	1
<input type="checkbox"/>	7	006.010230.000	FAIR LEAD BREATHING TUBE MEM	1
<input type="checkbox"/>	8	11.50360.000	BOLT 6.40 RS CH8	1
<input type="checkbox"/>	9	11.05535.000	BOLT 6.50 RS CH8	3
<input type="checkbox"/>	10	035.010188.200	PACKINGS KIT	1
<input type="checkbox"/>	12	10.66164.000	O.RING, 11.2 NBR 70SH	1
<input type="checkbox"/>	13	006.081528.000	MAGNET SCREW M14X1,5	1

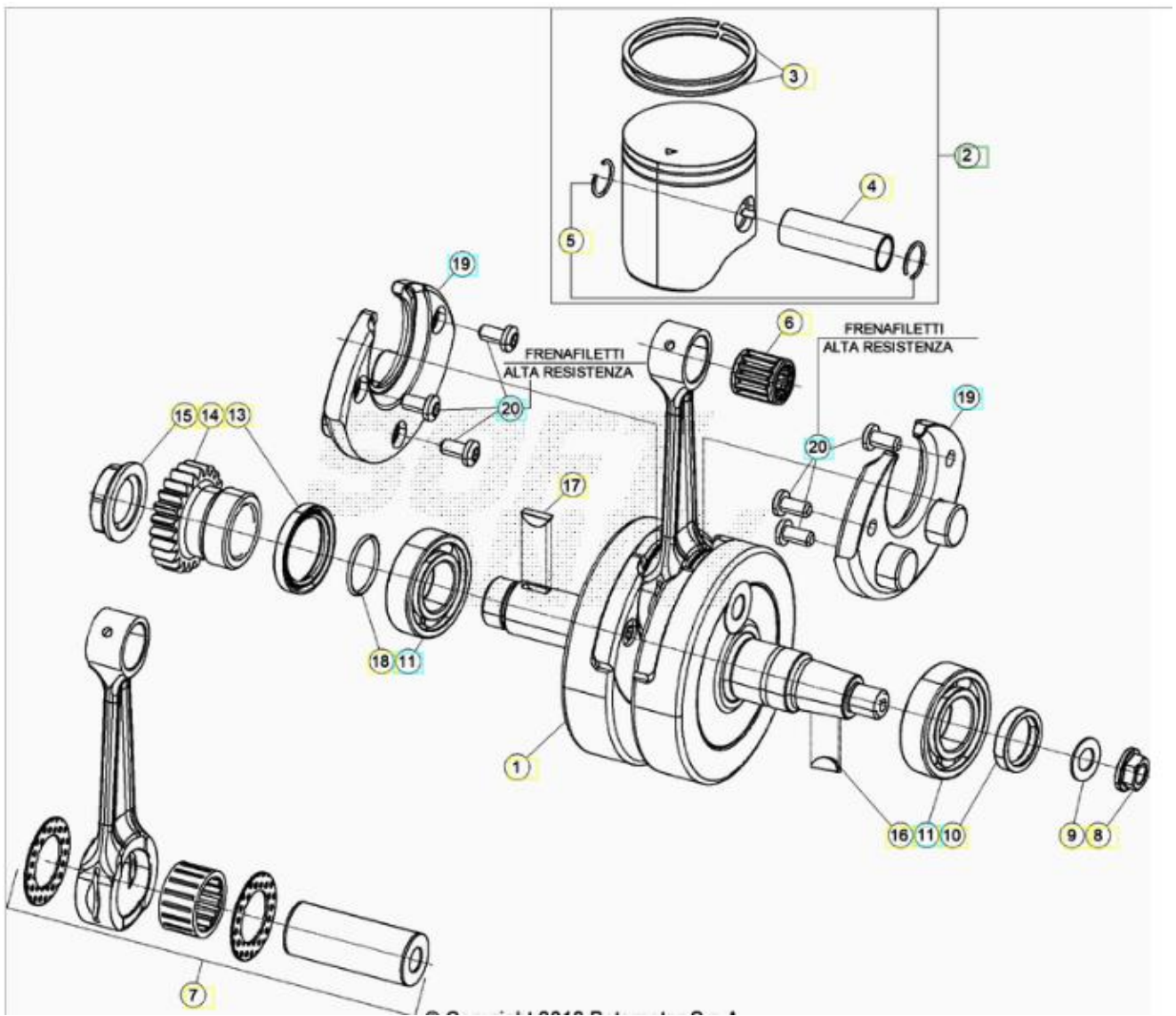

REF. NO.	PART NO.	CRANKSHAFT PISTON DESCRIPTION	200 RR 2T	
<input type="checkbox"/>	1	035.020308.000	CRANKSHAFT	1
<input type="checkbox"/>	2	035.020298.00A	PISTON KIT, 200CC A	1
<input type="checkbox"/>	2	035.020298.00B	PISTON KIT, 200CC B	1
<input type="checkbox"/>	2	035.020298.00C	PISTON KIT, 200CC C	1
<input type="checkbox"/>	3	035.020270.000	PISTON RING	1
<input type="checkbox"/>	4	035.020280.000	PISTON PIN	1
<input type="checkbox"/>	5	035.020310.000	CIRCLIP	1
<input type="checkbox"/>	6	16.14360.000	NEEDLE BEARING	1
<input type="checkbox"/>	7	035.020218.000	CONNECTING ROD ASSY	1
<input type="checkbox"/>	8	13.25010.000	NUT, MAGNETO SPECIAL	1
<input type="checkbox"/>	9	27.74810.000	SPRING WASHER DIN137 B12 FST	1
<input type="checkbox"/>	10	C02010410000	OIL SEAL 25X35X7	1
<input type="checkbox"/>	11	C06010430000	BEARING	2
<input type="checkbox"/>	13	10.66020.000	OIL SEAL 32.45.7 BSL	1
<input type="checkbox"/>	14	035.030010.000	MAIN DRIVE SPROCKET	1

<input type="checkbox"/>	15	006.030230.000	NUT M20X1,5LH (PRIMARY GEAR)	1
<input type="checkbox"/>	16	12.46020.000	KEY 3.5	1
<input type="checkbox"/>	17	12.46151.000	WOODRUFF, 4.5	1
<input type="checkbox"/>	18	10.66490.000	OIL SEAL 21,95.25,51.1,78	1
<input type="checkbox"/>	19	035.020030.000	CRANKSHAFT INSERT	2
<input type="checkbox"/>	20	C24910020000	SCREW 6.12 TORX	2

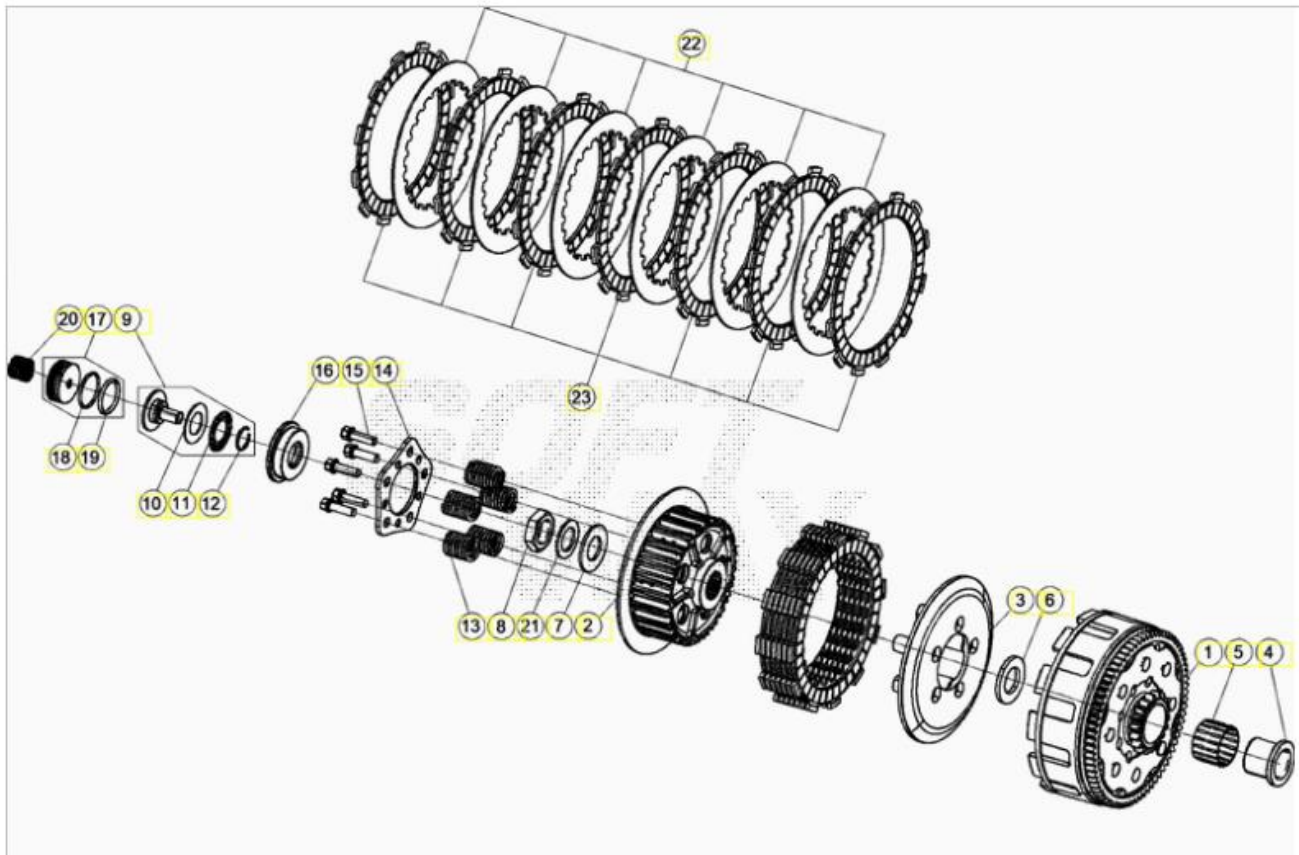

REF. NO.	PART NO.	CLUTCH DESCRIPTION	200 RR 2T	
<input type="checkbox"/>	1	035.030278.000	CLUTCH BASKET	1
<input type="checkbox"/>	2	035.030130.000	CLUTCH DRUM	1
<input type="checkbox"/>	3	035.030140.000	PRESSURE PLATE	1
<input type="checkbox"/>	4	035.030160.000	BUSH	1
<input type="checkbox"/>	5	006.030630.000	ROLLER BEARING 26.30.22	1
<input type="checkbox"/>	6	035.030180.000	WASHER	1
<input type="checkbox"/>	7	27.65891.000	WASHER	1
<input type="checkbox"/>	8	006.030650.000	S/ARM SPECIAL NUT 18.1,50	1
<input type="checkbox"/>	9	035.030208.000	CLUTCH COUPLING	1
<input type="checkbox"/>	10	C06610020000	WASHER	1
<input type="checkbox"/>	11	C06390048200	BEARING	1
<input type="checkbox"/>	12	28.24470.000	CIRCLIP	1
<input type="checkbox"/>	13	035.030170.000	CLUTCH SPRING	1
<input type="checkbox"/>	14	035.030150.000	SPRING COLLAR	1

<input type="checkbox"/>	15	11.49070.000	BOLT 6.20	1
<input type="checkbox"/>	16	035.030290.000	CLUTCH COUPLING PLATE	1
<input type="checkbox"/>	17	035.030218.000	ACTUATOR PISTON ASSY	1
<input type="checkbox"/>	18	10.66520.000	OIL SEAL 23,52.1,78	1
<input type="checkbox"/>	19	10.66510.000	OIL SEAL 21,89.2,62	1
<input type="checkbox"/>	20	035.030220.000	SPRING	1
<input type="checkbox"/>	21	C19420040000	WASHER	1
<input type="checkbox"/>	22	035.030240.000	DRIVEN PLATE	1
<input type="checkbox"/>	23	035.030100.000	DRIVING PLATE (FIBER)	1

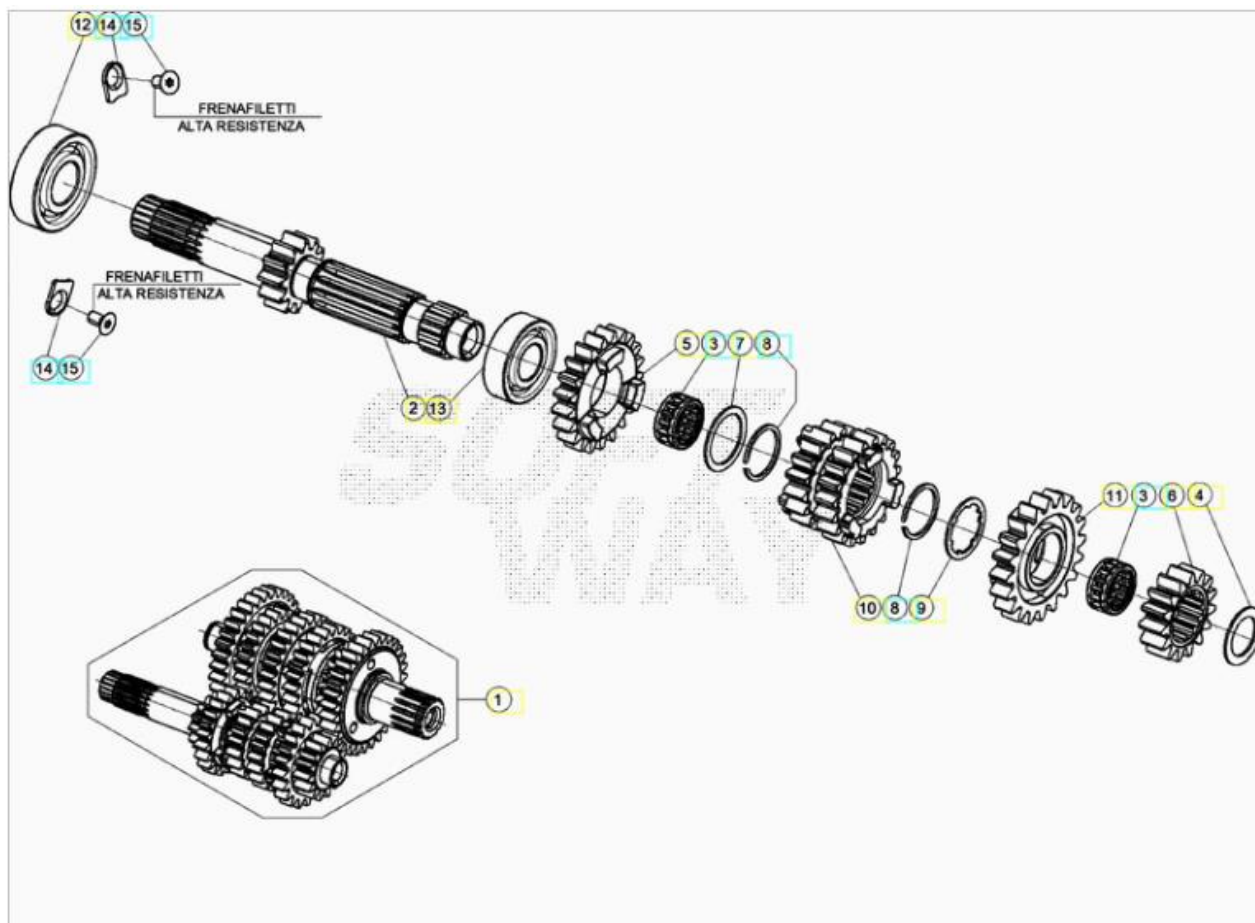

REF. NO.	PART NO.	GEARBOX ASSY. DESCRIPTION	200 RR 2T	
<input type="checkbox"/>	1	035.040258.000	GEARBOX ASSY	1
<input type="checkbox"/>	2	035.040260.000	GEARBOX MAINSHAFT	1
<input type="checkbox"/>	3	16.16580.000	NEEDLE BEARING 18.22.10, PLASTIC	2
<input type="checkbox"/>	4	035.040160.000	THRUST WASHER	1
<input type="checkbox"/>	5	035.040020.000	FIFTH GEAR . MAINSHAFT	1
<input type="checkbox"/>	6	035.040230.000	2° MAINSHAFT GEAR	1
<input type="checkbox"/>	7	C19040040000	WASHER 22.28.1	1
<input type="checkbox"/>	8	C01310050000	CHECK RING 22.1	2
<input type="checkbox"/>	9	035.040220.000	WASHER	1
<input type="checkbox"/>	10	035.040040.000	THIRD/FOURTH GEAR . MAINSHAFT	1

<input type="checkbox"/>	11	035.040060.000	6TH GEAR . MAINSHAFT	1
<input type="checkbox"/>	12	12.98001.000	BEARING	1
<input type="checkbox"/>	13	C06010360000	BEARING	1
<input type="checkbox"/>	14	006.010190.009	RETAINING PLATE (BALANCER SHAFT)	2
<input type="checkbox"/>	15	31.30085.000	COUNTERSUNK SCREW M5X10 8.8 "TORX"	2

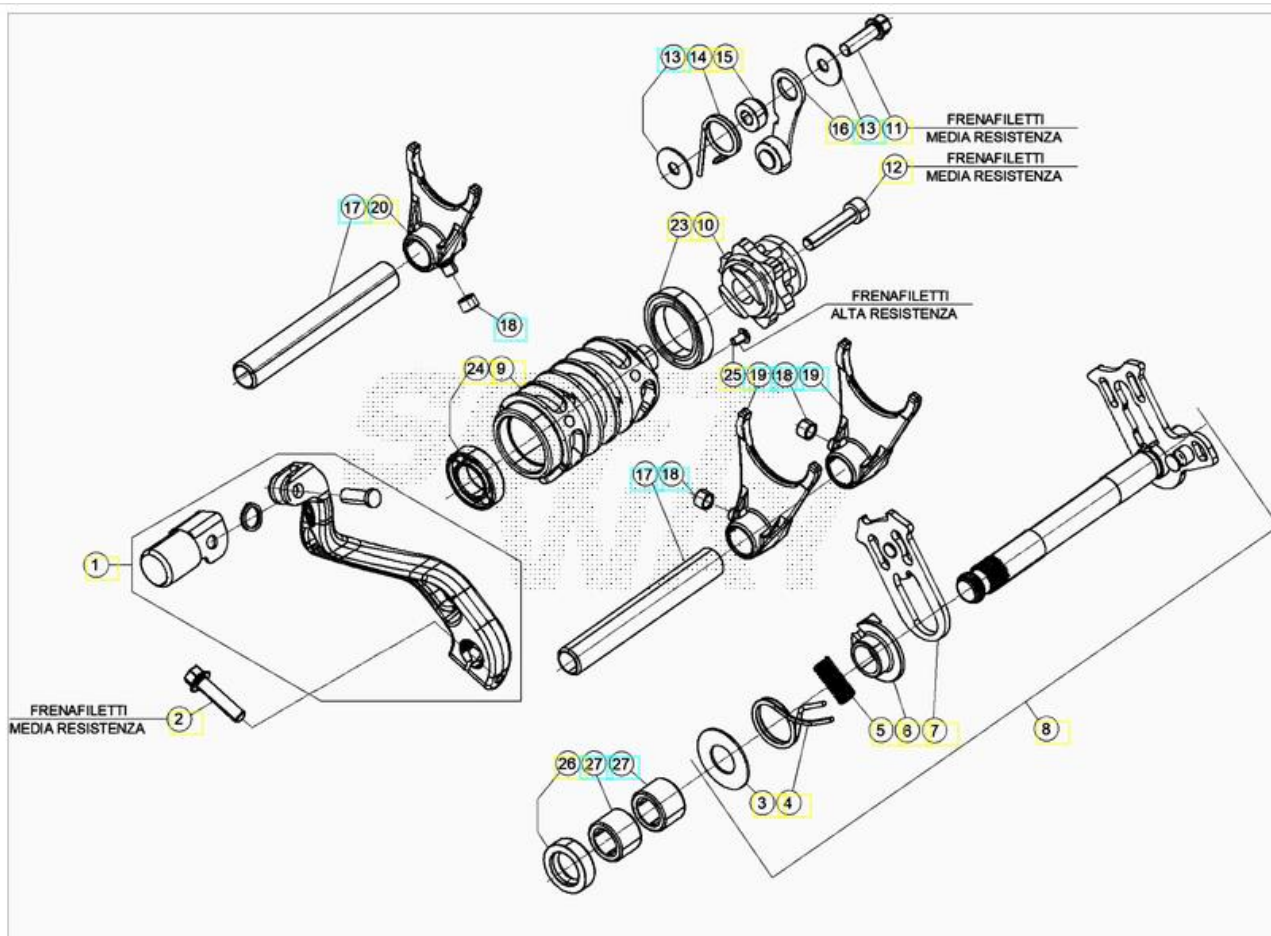

REF. NO.	PART NO.	GEAR SHIFT CONTROL DESCRIPTION	200 RR 2T	
<input type="checkbox"/>	1	006.050008.000	GEAR CHANGE LEVER CPL	1
<input type="checkbox"/>	2	11.50010.000	BOLT 6.25	1
<input type="checkbox"/>	3	27.63020.000	WASHER 14.30.1	1
<input type="checkbox"/>	4	006.050170.000	GEAR BOX RETURN SPRING	1
<input type="checkbox"/>	5	16.92911.000	SPRING GUIDE	1
<input type="checkbox"/>	6	006.050160.000	SHIFT SHAFT CPL.	1
<input type="checkbox"/>	7	006.050148.000	SHIFT SHAFT CPL.	1
<input type="checkbox"/>	8	035.050008.000	GEARSHIFT SHAFT ASSY	1
<input type="checkbox"/>	9	035.050060.000	SELECTOR DRUM	1
<input type="checkbox"/>	10	029.050018.000	DETENT CAM	1
<input type="checkbox"/>	11	11.49070.000	BOLT 6.20	1
<input type="checkbox"/>	12	31.45000.000	SCREW 6.30	1
<input type="checkbox"/>	13	27.42000.100	WASHER 6.20.1,0	2
<input type="checkbox"/>	14	035.050070.000	SPRING	1

<input type="checkbox"/>	15	029.050540.000	SPACER	1
<input type="checkbox"/>	16	029.050508.000	GEAR STOP LEVER	1
<input type="checkbox"/>	17	026.050250.000	SPINDLE FORK	2
<input type="checkbox"/>	18	006.050270.000	BUSHING 6.8.5,2	3
<input type="checkbox"/>	19	035.050040.000	GEAR SELECTOR FORK	2
<input type="checkbox"/>	20	035.050050.000	GEAR SELECTOR FORK	1
<input type="checkbox"/>	23	12.93405.000	BALL BEARING 61805.2RS1	1
<input type="checkbox"/>	24	12.93840.000	BALL BEARING 15.28.7	1
<input type="checkbox"/>	25	31.30084.000	COUNTERSUNK SCREW M5X8 "TORX 25"	1
<input type="checkbox"/>	26	10.52012.000	OIL SEAL 14.24.6 B1SL	1
<input type="checkbox"/>	27	11.22320.000	NEEDLE BEARING HK1414RS	2

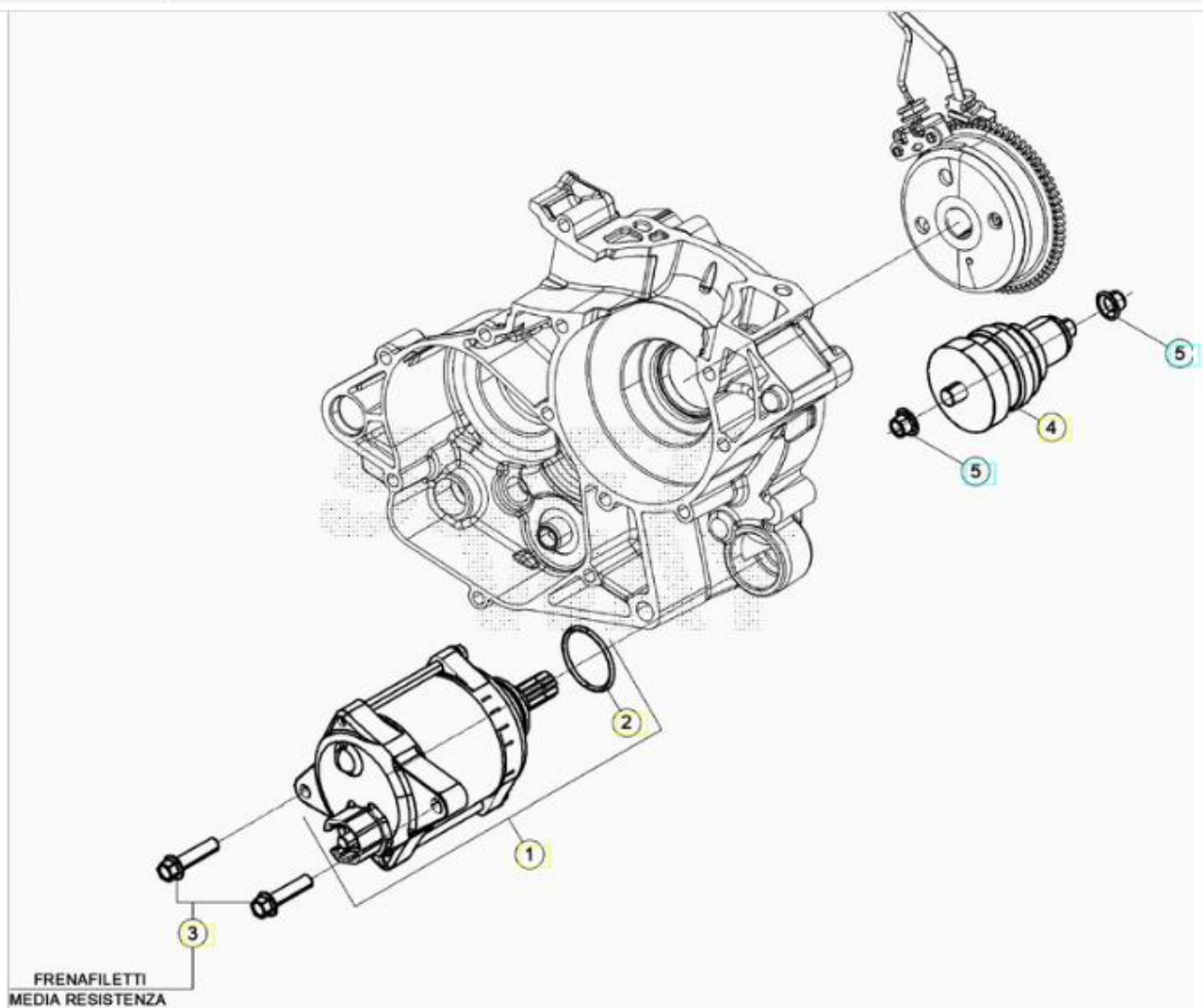

REF. NO.	PART NO.	ELECTRIC STARTER DESCRIPTION	200 RR 2T	
<input type="checkbox"/>	1	035.070038.000	STARTER MOTOR	1
<input type="checkbox"/>	2	36.25056.000	O RING 25,00X3,00 NBR70	1
<input type="checkbox"/>	3	11.50010.000	BOLT 6.25	1
<input type="checkbox"/>	4	026.070100.000	CONTACT TAG, BENDIX	1
<input type="checkbox"/>	5	C03020010000	BUSH 8X10X8	2

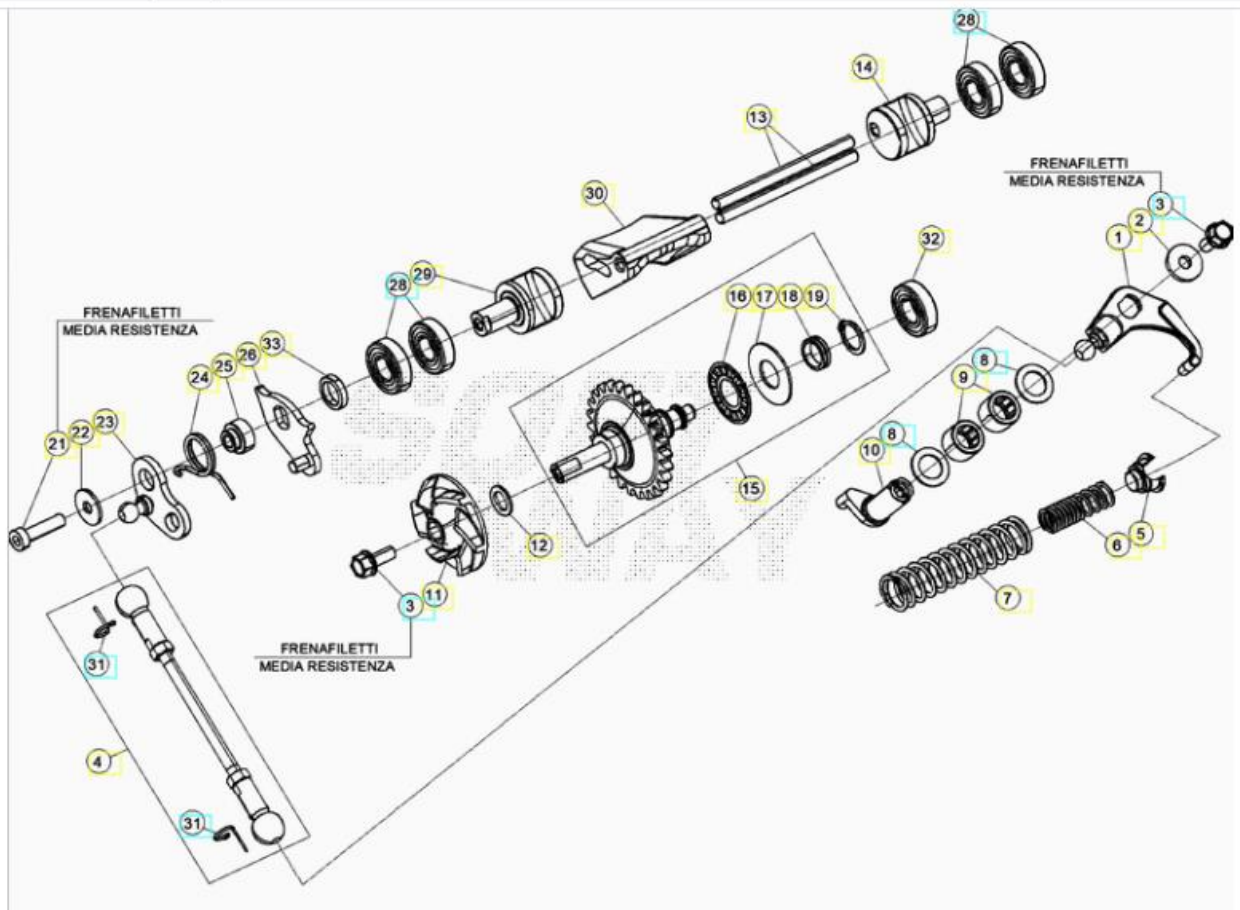

REF. NO.	PART NO.	ROCKER ARM ASSY. DESCRIPTION	200 RR 2T	
<input type="checkbox"/>	1	035.090228.000	RELAY ARM	1
<input type="checkbox"/>	2	C16020010000	WASHER 5.15.2 DIN 7349	1
<input type="checkbox"/>	3	11.46251.000	BOLT 5,12	2
<input type="checkbox"/>	4	026.090158.000	VALVE CONTROL ROD	1
<input type="checkbox"/>	5	026.090170.000	SPRING GUIDE	1
<input type="checkbox"/>	6	026.090180.000	SPRING	1
<input type="checkbox"/>	7	026.090210.000	ADJUSTING SPRING 250CC	1
<input type="checkbox"/>	8	27.58400.000	SHIM WASHER	2
<input type="checkbox"/>	9	11.22100.000	NEEDLE BEARING 10.14.10	1
<input type="checkbox"/>	10	026.090110.000	CONTROL LEVER	1
<input type="checkbox"/>	11	006.090000.000	IMPELLER WATER PUMP	1
<input type="checkbox"/>	12	006.090120.000	WASHER WATER PUMP	1
<input type="checkbox"/>	13	035.090040.000	EXHAUST VALVE PIN	1
<input type="checkbox"/>	14	035.090230.000	BOOSTER VALVE	1
<input type="checkbox"/>	15	035.090158.000	CENTRIFUGE	1
<input type="checkbox"/>	16	16.11512.000	AXIAL NEEDLE BEARING 12.26	1
<input type="checkbox"/>	17	27.56400.000	WASHER AS1226	1
<input type="checkbox"/>	18	035.090170.000	SPACER	1
<input type="checkbox"/>	19	28.22760.000	SEEGER A12 DIN 471	1



<input type="checkbox"/>	21	31.30015.000	SCREW 5.20	1
<input type="checkbox"/>	22	27.36500.000	WASHER 5.15	1
<input type="checkbox"/>	23	035.090208.500	LEVER	1
<input type="checkbox"/>	24	035.090250.000	SPRING	1
<input type="checkbox"/>	25	026.090440.000	SPACER	1
<input type="checkbox"/>	26	035.090198.500	LEVER	1
<input type="checkbox"/>	28	12.93410.000	BEARING 10.22.6. 2RS1	2
<input type="checkbox"/>	29	035.090240.000	BOOSTER VALVE	1
<input type="checkbox"/>	30	035.090140.000	EXHAUST VALVE	1
<input type="checkbox"/>	31	C21310010000	LOCKING SPRING	2
<input type="checkbox"/>	32	12.93387.000	BALL BEARING 6.19.6	1
<input type="checkbox"/>	33	026.090470.000	SPACER	1

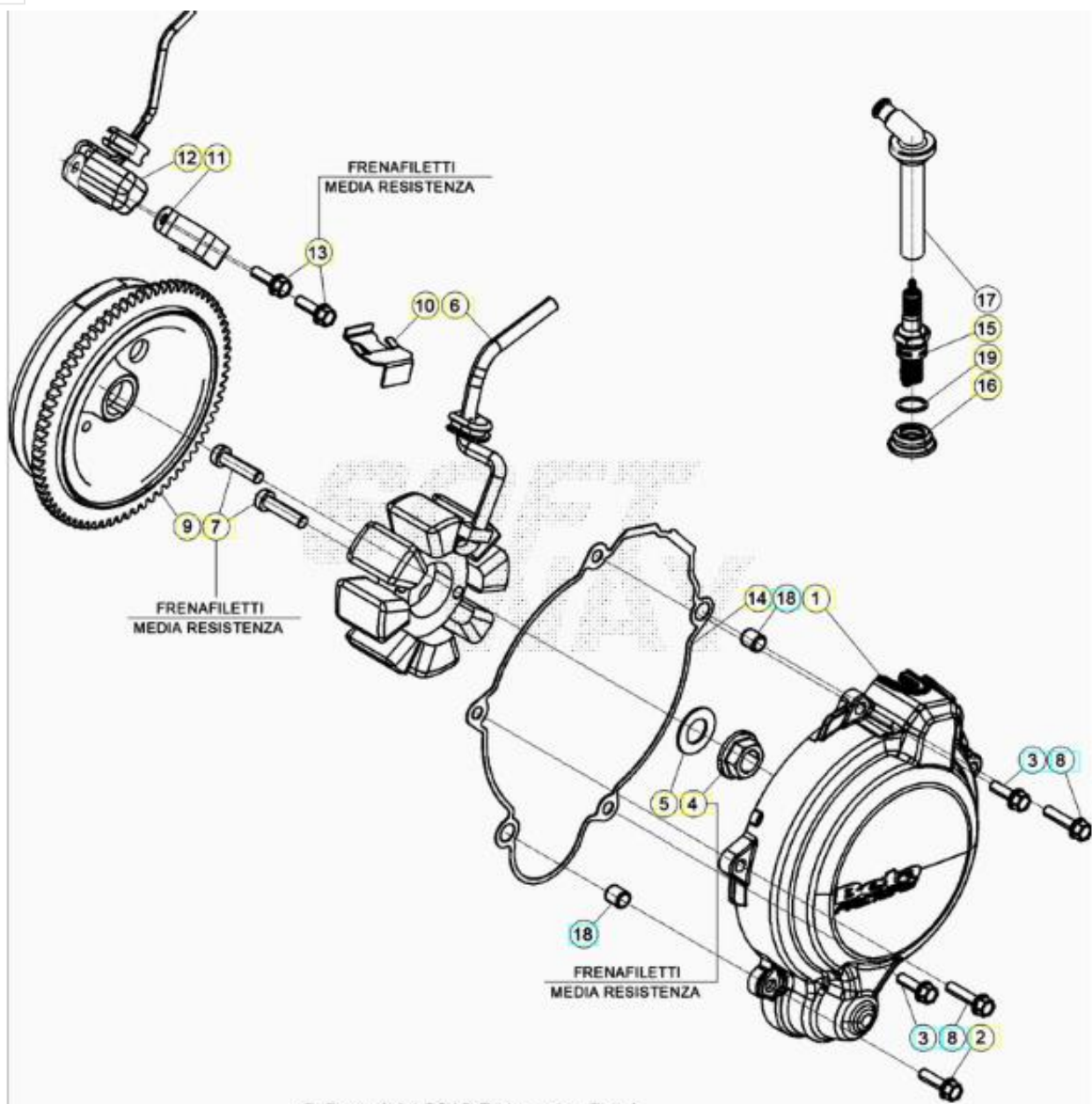







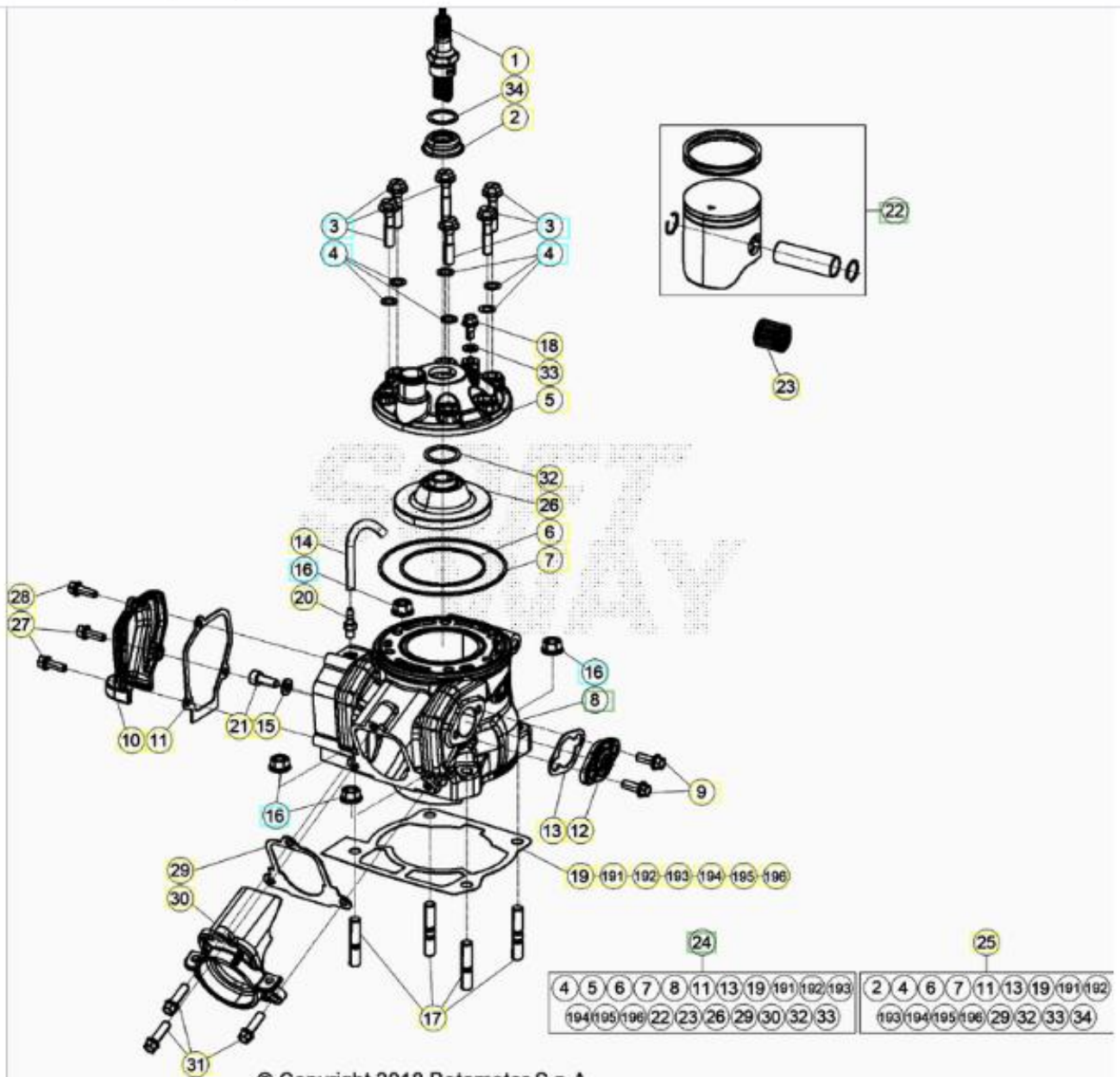





© Copyright 2018 Rotamotor S.p.A

REF. NO.	PART NO.	FLYWHEEL W/ COVER DESCRIPTION	200 RR 2T
<input type="checkbox"/>	1	035.010148.059	FLYWHEEL COVER

	2	11.50010.000	BOLT 6.25	1
	3	11.49070.000	BOLT 6.20	2
	4	13.25010.000	NUT, MAGNETO SPECIAL	1
	5	27.74810.000	SPRING WASHER DIN137 B12 FST	1
	6	026.100050.000	GENERATOR	1
	7	31.48507.000	SCREW 6.25	1
	8	11.50355.000	BOLT 6.35 RS CH8	2
	9	035.100018.500	ROTOR	1
	10	006.010540.000	CABLE RETAINING PLATE	1
	11	035.100040.000	RETAINING PLATE	1
	12	026.100060.000	PICKUP	1
	13	11.46360.000	BOLT 5,16	1
	14	035.010150.000	ALTERNATOR COVER GASKET	1
	15	12.25123.000	SPARKPLUG, BR8ECM	1
	16	026.100120.000	SPARK PLUG GASKET	1
	17	27.13514.000	SPARK PLUG PROTECTOR CR65.2001	1
	18	16.36500.000	DOWEL 9.10	2
	19	C02060520000	O.RING 17.96X2.62	1







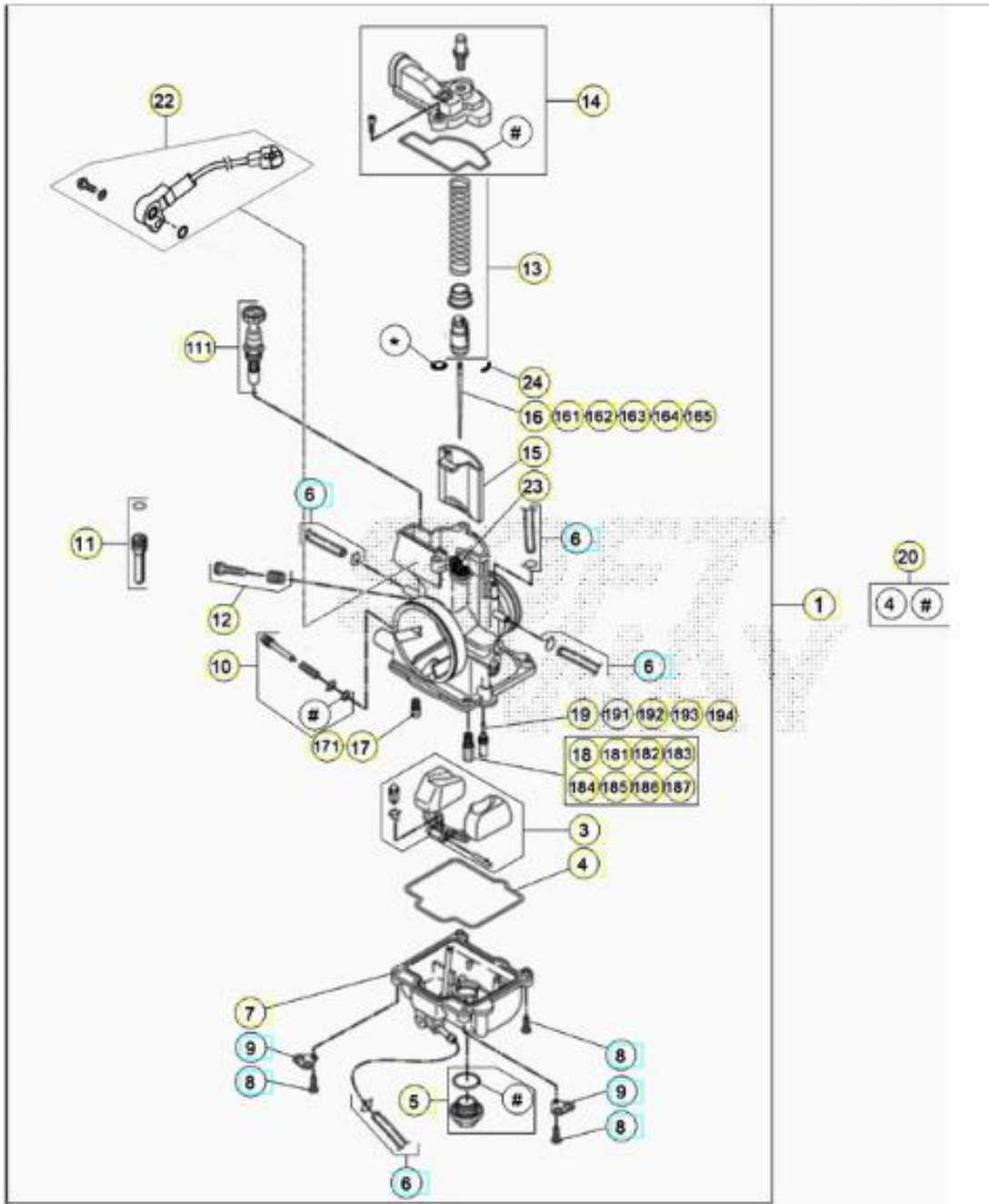





















REF. NO.	PART NO.	CYLINDER ASSY DESCRIPTION	200 RR 2T	
<input type="checkbox"/>	1	12.25123.000	SPARKPLUG, BR8ECM	1
<input type="checkbox"/>	2	026.100120.000	SPARK PLUG GASKET	2
<input type="checkbox"/>	3	11.52429.000	SPECIAL BOLT 7.31	2
<input type="checkbox"/>	4	27.45100.000	WASHER 7.12.0,2	4
<input type="checkbox"/>	5	035.110070.059	CYLINDER HEAD COVER	2
<input type="checkbox"/>	6	C02060640000	OIL SEAL	2
<input type="checkbox"/>	6	C02060640000	OIL SEAL	1
<input type="checkbox"/>	7	C02060610000	OIL SEAL	2
<input type="checkbox"/>	7	C02060610000	OIL SEAL	1
<input type="checkbox"/>	8	035.110280.00A	CYLINDER, 200CC A	2
<input type="checkbox"/>	8	035.110280.00B	CYLINDER, 200CC B	1
<input type="checkbox"/>	9	11.48025.000	BOLT 6.16	1
<input type="checkbox"/>	10	035.110324.059	COVER	1

	11	035.110330.000	GASKET	3
	12	035.110130.059	COVER	1
	13	035.110180.000	GASKET	3
	14	026.110120.000	TUBE	1
	15	27.40500.000	WASHER 6.12.1,6 DIN 125	1
	16	035.110190.000	NUT	3
	17	25.98055.000	STUD BOLT 8.30	1
	18	11.47018.000	BOLT 6.12	1
	19	035.110100.000	CYLINDER GASKET .3	3
	20	29.00280.000	PLUG FOR HEAD RS 4T USA	1
	21	31.31050.000	SCREW 6.15	1
	22	035.020298.00A	PISTON KIT, 200CC A	2
	22	035.020298.00B	PISTON KIT, 200CC B	1
	22	035.020298.00C	PISTON KIT, 200CC C	1
	23	16.14360.000	NEEDLE BEARING	2
	24	035.110368.20A	GASKET KIT ORDER PARTS INDIVIDUALLY	1
	24	035.110368.20B	GASKET KIT ORDER PARTS INDIVIDUALLY	1
	25	035.110378.200	TOP END GASKET KIT, 200CC	1
	26	035.110390.000	COMPRESSION CHAMBER, 200CC	2
	27	11.46360.000	BOLT 5,16	1
	28	026.110360.000	TAB SCREW	1
	29	035.110340.000	GASKET	3
	30	035.110300.000	EXHAUST FLANGE	2
	31	11.49070.000	BOLT 6.20	1
	32	10.66505.000	O.RING 22.27.2,5 VYTON	3
	33	27.40495.000	WASHER 6.11.0,8	3
	34	C02060520000	O.RING 17.96X2.62	1
	34	C02060520000	O.RING 17.96X2.62	1
	191	035.110110.000	CYLINDER GASKET .4	3
	192	035.110120.000	CYLINDER GASKET .5	3
	193	035.110220.000	CYLINDER GASKET .125	3
	194	035.110230.000	CYLINDER GASKET .2	3
	195	035.110240.000	CYLINDER GASKET .25	3
	196	035.110250.000	CYLINDER GASKET .6	3



REF. NO.	PART NO.	CARBURETTOR COMPONENTS DESCRIPTION	200 RR 2T	
<input type="checkbox"/>	1	035.120108.200	CARBURETOR, 200RR	1
<input type="checkbox"/>	3	026.120098.000	FLOAT ASSEMBLY	1
<input type="checkbox"/>	4	026.120110.000	FLOAT CHAMBER GASKET	2
<input type="checkbox"/>	5	026.121068.000	CAP DRAIN ASSY	1
<input type="checkbox"/>	6	026.120450.000	KIT, TUBE	4
<input type="checkbox"/>	7	026.121070.000	CHAMBER ASSY	1
<input type="checkbox"/>	8	026.120160.000	SCREW M4X16	3
<input type="checkbox"/>	9	026.120240.000	PLATE	2
<input type="checkbox"/>	10	026.120288.000	ADJUSTING SCREW KIT	1
<input type="checkbox"/>	11	026.120068.000	SLIDE STOP ASSY	1
<input type="checkbox"/>	12	026.120328.000	ADJUSTING SCREW ASSEMBLY	1

	13	026.120378.000	CARB SPRING	1
	14	026.120600.000	CARB COVER	1
	15	026.121050.000	CARB VALVE	1
	16	006.120160.000	JET NEEDLE KEIHIN N84J	1
	17	035.120110.000	CHOKE JET 35	1
	18	035.120130.000	MAIN JET 65	1
	20	026.120440.000	PACKINGS KIT	1
	22	036.120040.000	TPS	1
	23	25.57912.000	RETAINING PLATE	1
	24	12.54242.000	CLIP, JET NEEDLE	1
	111	026.120080.000	STARTER PISTON	1
	161	035.120150.000	NEEDLE N1EG	1
	162	035.120140.000	NEEDLE N1EH	1
	163	036.120050.000	JET NEEDLE KEIHIN N1EI	1
	164	036.120030.000	JET NEEDLE KEIHIN N1EJ	1
	165	036.120060.000	JET NEEDLE KEIHIN N1EK	1
	171	026.120460.000	STARTER JET 85 KEIHINJ	1
	181	36.25104.000	MAIN JET 155 KEIHIN	1
	182	36.25105.000	MAIN JET 158 KEIHIN	1
	183	36.25106.000	MAIN JET 160 KEIHIN	1
	184	36.25107.000	MAIN JET 162 KEIHIN	1
	186	36.25109.000	MAIN JET 168 KEIHIN	1
	187	035.120090.000	MAIN JET 160	1
	191	16.42347.000	PILOT JET SIZE 42	1
	192	16.42349.000	PILOT JET SIZE 45	1
	193	16.42348.000	PILOT JET SIZE 48	1
	194	16.42344.000	PILOT JET SIZE 50	1

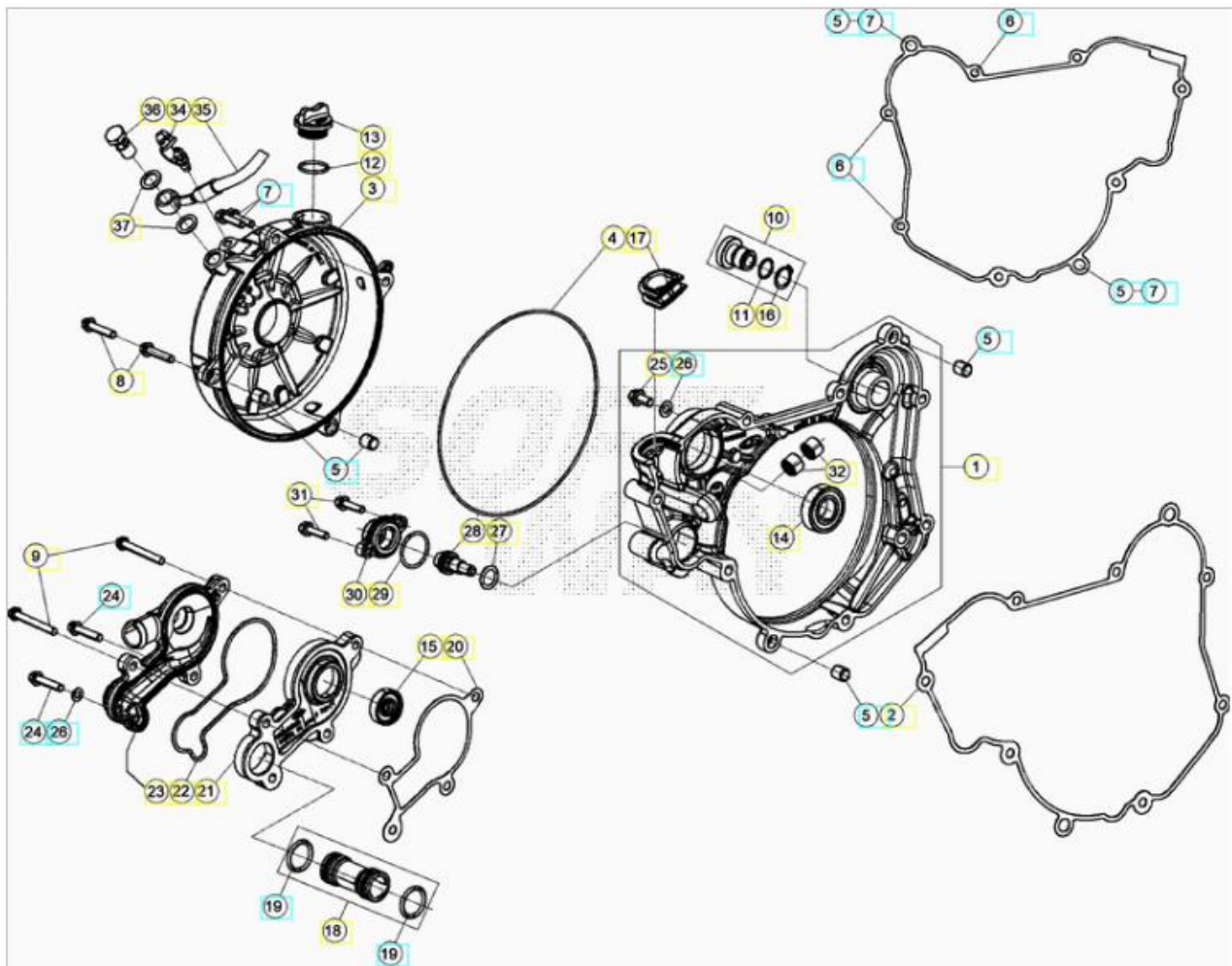

REF. NO.	PART NO.	CLUTCH COVER DESCRIPTION	200 RR 2T	
<input type="checkbox"/>	1	035.010118.059	INNER CLUTCH COVER	1
<input type="checkbox"/>	2	035.010090.000	CLUTCH COVER GASKET	1
<input type="checkbox"/>	3	035.010308.059	CLUTCH COVER	1
<input type="checkbox"/>	4	035.010080.059	CLUTCH COVER GASKET	1
<input type="checkbox"/>	5	16.36500.000	DOWEL 9.10	5
<input type="checkbox"/>	6	11.49070.000	BOLT 6.20	2
<input type="checkbox"/>	7	11.50010.000	BOLT 6.25	3
<input type="checkbox"/>	8	11.05535.000	BOLT 6.50 RS CH8	1
<input type="checkbox"/>	9	11.05485.000	BOLT 6.60	1
<input type="checkbox"/>	10	035.010318.059	PLUG	1
<input type="checkbox"/>	11	10.52000.000	O.RING 14X1.78	1
<input type="checkbox"/>	12	10.66321.000	OIL SEAL	1
<input type="checkbox"/>	13	026.010198.059	OIL FILLER CAP	1
<input type="checkbox"/>	14	C06010010000	BEARING 15X32X9	1
<input type="checkbox"/>	15	10.43720.000	OIL SEAL	1
<input type="checkbox"/>	16	28.24460.000	SEEGER 16.1 A16 DIN 471	1
<input type="checkbox"/>	17	035.010348.200	INSERT	1
<input type="checkbox"/>	18	026.010378.000	WATER PIPE, COMPLETE	1

□	19	C02060520000	O.RING 17.96X2.62	2
□	20	035.010240.000	GASKET	1
□	21	035.010210.000	WATER PUMP PLUNGER CYLINDER	1
□	22	035.010230.000	OIL SEAL	1
□	23	035.010200.000	WATER PUMP COVER	1
□	24	11.50300.000	BOLT 6.30 RS CH8	2
□	25	11.47015.000	BOLT 6.12 RS CH8	1
□	26	27.40495.000	WASHER 6.11.0,8	2
□	27	10.66296.000	O.RING 12,37,2,62 NBR70	1
□	28	026.090200.000	SPRING GUIDE	1
□	29	10.66540.000	O.RING 24.2 NBR70	1
□	30	026.090250.000	COVER	1
□	31	11.46401.000	BOLT 5.20 RS CH8	1
□	32	11.22100.000	NEEDLE BEARING 10.14.10	1
□	34	28.91050.800	BLEED WITH RUBBER	1
□	35	035.350020.000	CLUTCH TUBE	1
□	36	11.65040.000	SPECIAL BOLT	1
□	37	16.50510.000	GASKET 10.15.1 COPPER	1

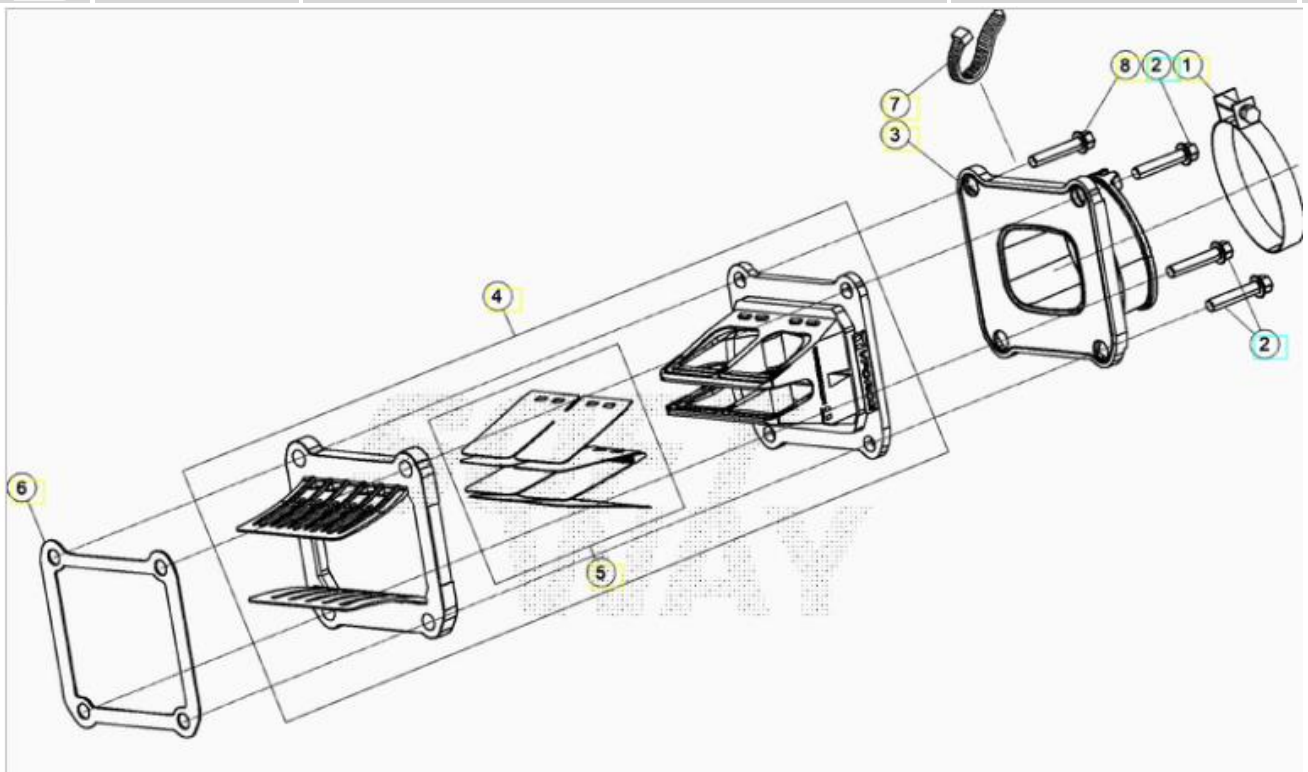

REF. NO.	PART NO.	REED VALVE DESCRIPTION	200 RR 2T	
□	1	15.14275.000	CLAMP, 52/12	1
□	2	11.50010.000	BOLT 6.25	2
□	3	035.010108.200	CARB INTAKE BOOT	1
□	4	035.010168.000	LEAF VALVE ASSY	1



<input type="checkbox"/>	5	035.010078.200	PLATE KIT	1
<input type="checkbox"/>	6	035.010190.000	SUCTION VALVE GASKET	1
<input type="checkbox"/>	7	C07190010000	RUBBER BAND CLAMP	1
<input type="checkbox"/>	8	026.110350.000	SECURITY SCREW	1

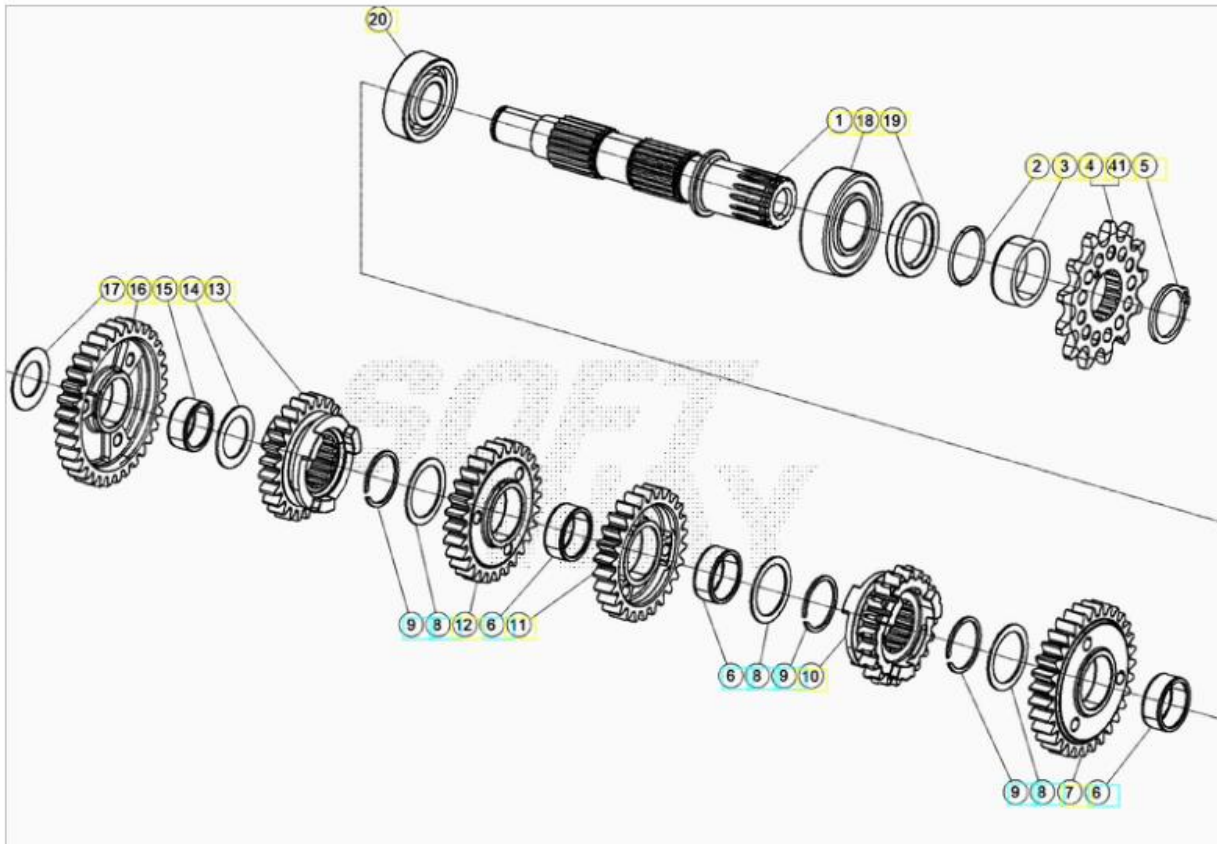

REF. NO.	PART NO.	COUNTERSHAFT DESCRIPTION	200 RR 2T	
<input type="checkbox"/>	1	035.040208.000	COUNTER SHAFT	1
<input type="checkbox"/>	2	10.66620.000	OIL SEAL	1
<input type="checkbox"/>	3	006.040400.000	DISTANCE BUSH	1
<input type="checkbox"/>	4	006.040510.000	FR. SPROCKET 14T, RR/RS	1
<input type="checkbox"/>	5	28.25530.000	SEEGER AS 25X2 DIN 471	1
<input type="checkbox"/>	6	11.22845.000	NEEDLE BEARING K 20.24.10 (SPLITTED)	3
<input type="checkbox"/>	7	035.040240.000	2° COUNTERSHAFT GEAR	1
<input type="checkbox"/>	8	035.040030.000	WASHER	3
<input type="checkbox"/>	9	C01310080000	CHECK RING	3
<input type="checkbox"/>	10	035.040190.000	6TH GEAR C/S	1
<input type="checkbox"/>	11	035.040120.000	FOURTH GEAR . COUNTERSHAFT	1
<input type="checkbox"/>	12	035.040110.000	THIRD GEAR . COUNTERSHAFT	1
<input type="checkbox"/>	13	035.040180.000	5TH GEAR C/S	1
<input type="checkbox"/>	14	27.73635.000	THRUST WASHER	1
<input type="checkbox"/>	15	11.22835.000	NEEDLE BEARING K 20.24.10	1
<input type="checkbox"/>	16	035.040140.000	1ST GEAR . COUNTERSHAFT	1

<input type="checkbox"/>	17	006.040320.000	THRUST WASHER 17.30.1	1
<input type="checkbox"/>	18	12.95610.000	BALL BEARING (6205) C3	1
<input type="checkbox"/>	19	10.66020.000	OIL SEAL 32.45.7 BSL	1
<input type="checkbox"/>	20	C06010360000	BEARING	1
<input type="checkbox"/>	41	006.040520.000	FR. SPROCKET 15T, RR/RS	1

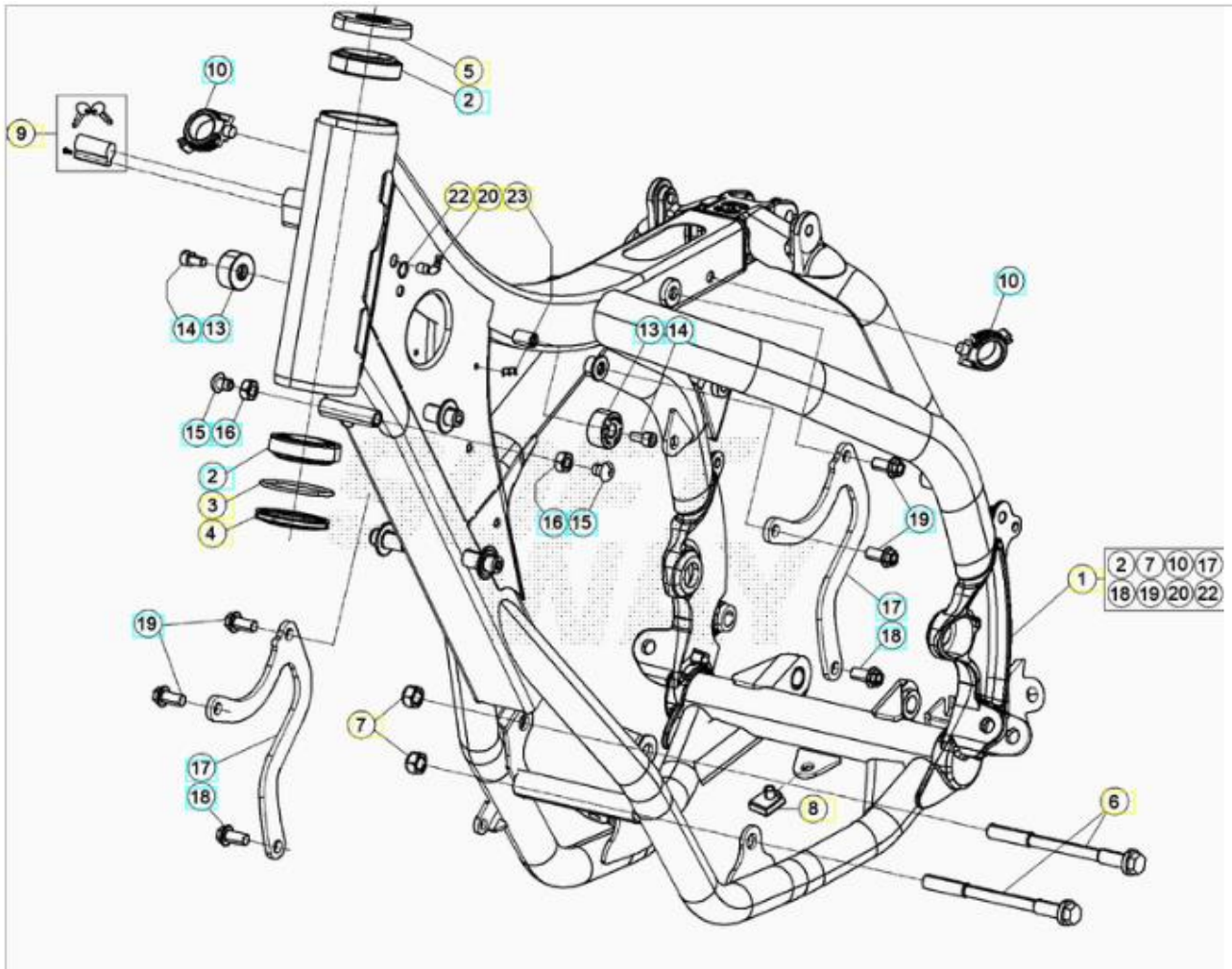





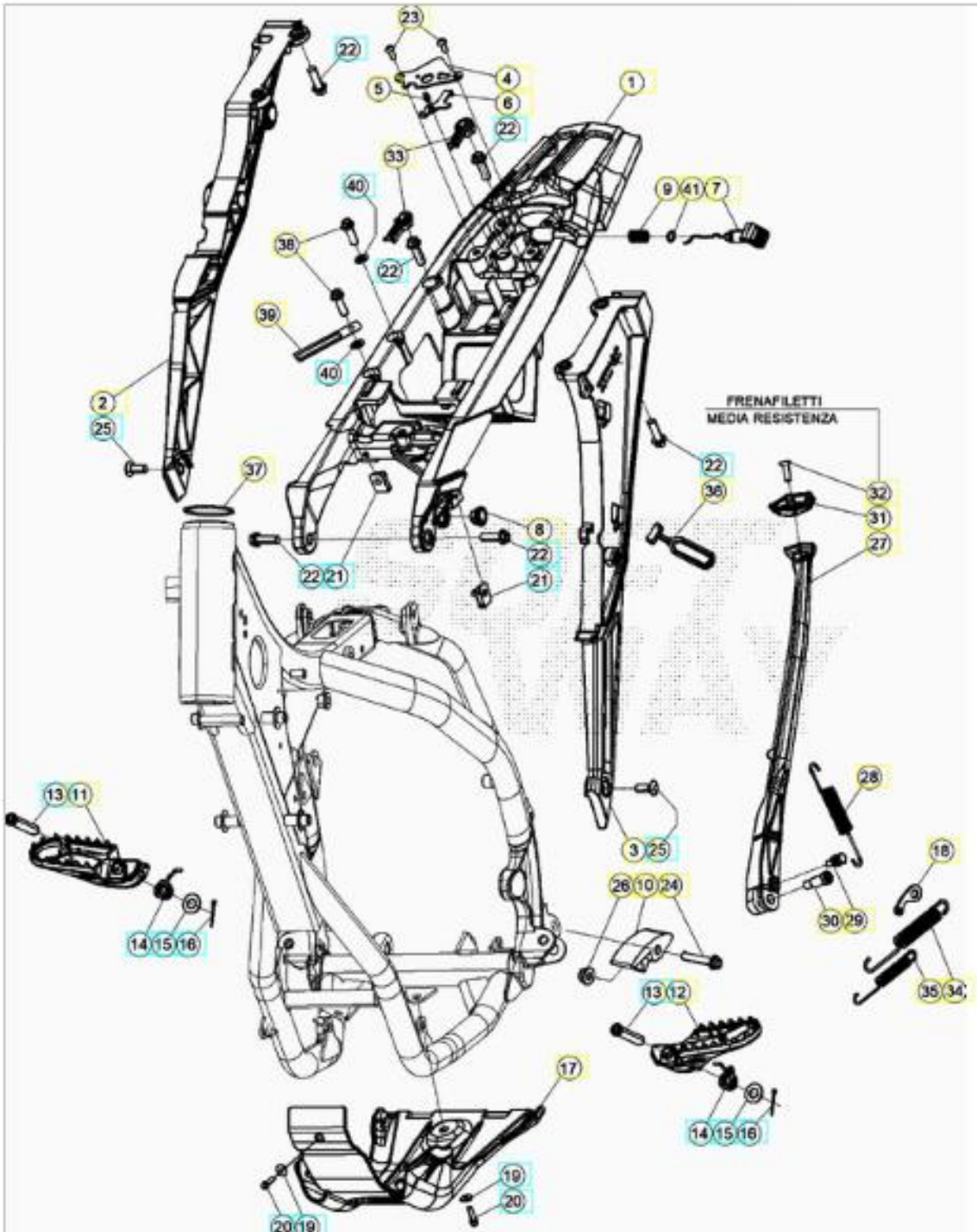

REF. NO.	PART NO.	FRAME DESCRIPTION	200 RR 2T	
<input type="checkbox"/>	1	041.310248.050	FRAME RED 200 RR	1
<input type="checkbox"/>	2	12.99510.000	BEARING 29.50.15	3
<input type="checkbox"/>	3	10.66935.000	O RING	1
<input type="checkbox"/>	4	020.310390.000	FRONT FORK RING, RR	1
<input type="checkbox"/>	5	031.310162.200	PROTECTION, UPPER BEARING	1
<input type="checkbox"/>	6	11.64607.000	SPECIAL BOLT	1
<input type="checkbox"/>	7	13.21060.000	NUT, M10X1,25 H.8.5 14MM SELF.LOCKI	2
<input type="checkbox"/>	8	25.60311.000	M6 SCREW PLATE	1
<input type="checkbox"/>	9	037.310240.000	STEERING LOCK PIN TUMBLER	1
<input type="checkbox"/>	10	037.370203.700	FAIRLEAD	1
<input type="checkbox"/>	10	25.24441.000	FAIR LEAD D.15, RR 4T	2
<input type="checkbox"/>	13	29.10310.000	TANK RUBBER PAD TR34	2
<input type="checkbox"/>	14	31.31050.000	SCREW 6.15	2

	15	31.64020.000	SCREW 8.20	2
	15	31.63890.000	SCREW 8.20	1
	16	13.16000.000	NUT 8.6	2
	17	041.320025.000	ENGINE CONNECTION	3
	18	11.54521.000	BOLT 8.16 CH.10	4
	18	11.54492.000	BOLT 8.20	2
	20	27.23473.000	OIL BREATHER JOINT	2
	22	27.33741.000	RIVET	2
	23	25.24443.000	FAIR LEAD, 6/6	1









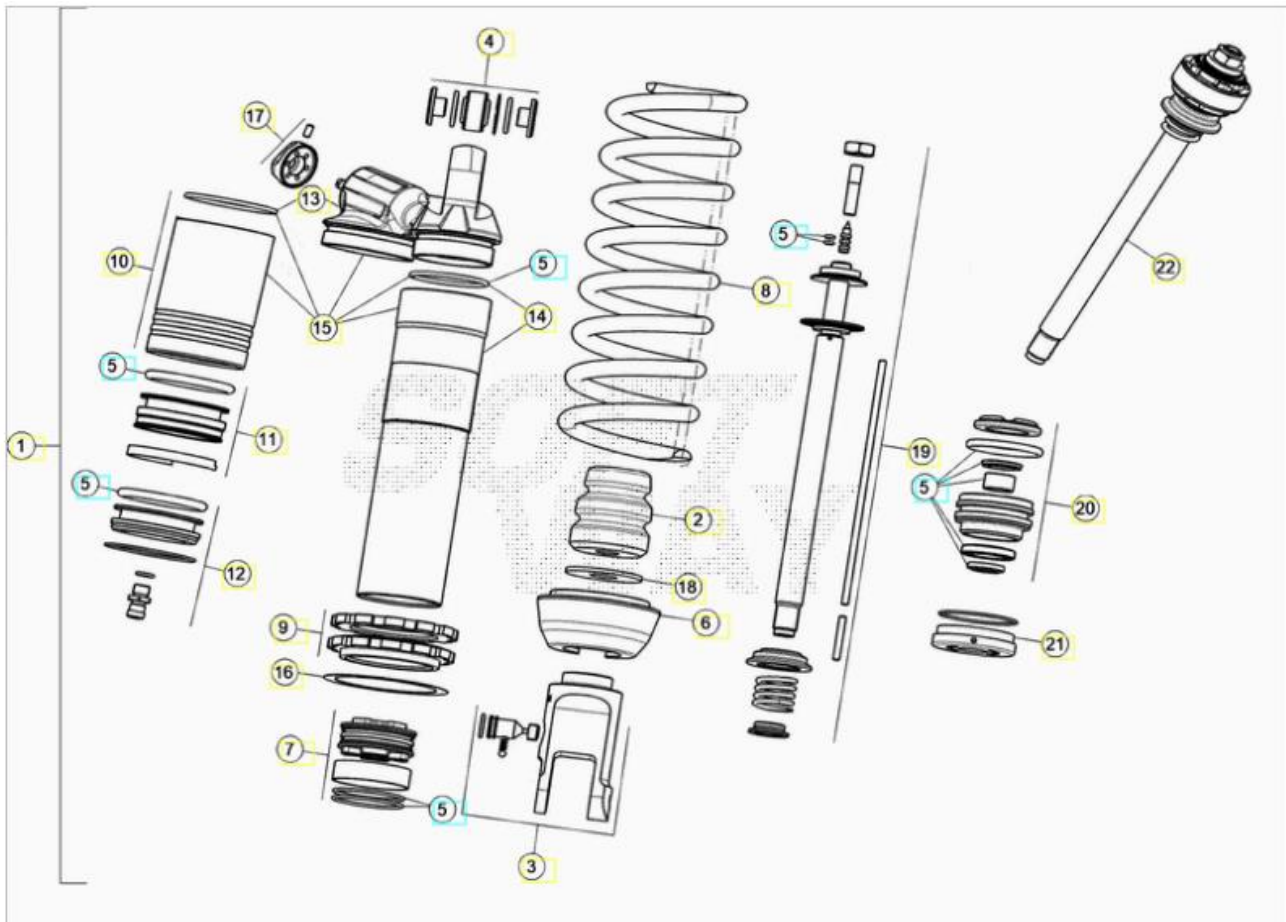







REF. NO.	PART NO.	FRAME ACCESSORIES DESCRIPTION	200 RR 2T
	1	040.320358.059	REAR FRAME

	2	037.320338.759	SUB FRAME . RIGHT	1
	3	037.320348.759	SUB FRAME . LEFT	1
	4	020.320100.005	SEAT LOCK FIXING PLATE	1
	5	020.321120.000	SEAT LOCK SPECIAL RIVET	1
	6	037.320135.000	RETAINING PLATE	1
	7	037.320148.759	SEAT BUTTON	1
	8	037.380030.000	INSERT 2T	1
	9	020.320160.000	SEAT LOCK BUTTON SPRING	1
	10	25.25601.000	SLIDING BLOCK	1
	11	037.320090.000	FOOTPEG	1
	12	037.320080.000	FOOTPEG	1
	13	25.54465.000	PIVOT PIN, FOOTREST RR 4T	2
	14	037.320190.000	SPRING	2
	15	031.320010.000	WASHER 10.21.2	2
	16	12.81993.000	SPLIT PIN	2
	17	041.320040.059	SKID PLATE 125/200RR	1
	18	037.320315.000	STAND SPRING BRACKET	1
	19	27.42000.000	WASHER 6.18	2
	20	11.49070.000	BOLT 6.20	2
	21	25.60311.000	M6 SCREW PLATE	2
	22	31.64070.000	SCREW 8.30	6
	23	31.29810.000	SCREW 5.12	1
	24	11.55480.000	BOLT 8.40	1
	25	007.320320.000	SCREW TSBEI CH 6 M8X20	2
	26	13.17120.000	NUT M8	1
	27	037.320108.200	KICKSTAND, 2020	1
	28	037.320300.000	SPRING	1
	29	11.66615.000	SPECIAL BOLT	1
	30	11.66614.000	SPECIAL BOLT, RR 4T '08	1
	31	037.320170.000	INSERT	1
	32	31.34400.000	SCREW 6.20	1
	33	037.320270.000	RUBBER PAD . KIT	1
	34	037.320290.000	SPRING	1
	35	037.320280.000	SPRING	1
	36	16.34907.000	STAND RUBBER, RR 4T	1
	37	031.320070.000	OIL SEAL	1
	38	11.50355.000	BOLT 6.35 RS CH8	1

<input type="checkbox"/>	39	032.350490.000	TIE WRAP	1
<input type="checkbox"/>	40	27.40500.000	WASHER 6.12.1,6 DIN 125	2
<input type="checkbox"/>	41	C02060660000	SEALING RING 9.52X1.78	1



REF. NO.	PART NO.	REAR SHOCK ABSORBER DESCRIPTION	200 RR 2T	
<input type="checkbox"/>	1	041.330018.000	SHOCK ABSORBER RR 2T 200	1
<input type="checkbox"/>	2	037.330090.000	SHOCK ABSORBER BUMPER	1
<input type="checkbox"/>	3	037.330100.000	SHOCK ABSORBER FORK	1
<input type="checkbox"/>	4	13.86078.800	SHOCK ABSORBER SPACERS *SET*	1
<input type="checkbox"/>	5	037.330118.200	GASKET . KIT	6
<input type="checkbox"/>	6	037.330070.000	SPRING CAP	1
<input type="checkbox"/>	7	026.330200.000	PISTON	1
<input type="checkbox"/>	8	026.330220.000	SHOCK SPRING	1
<input type="checkbox"/>	8	AB.10150.44	SHOCK SPRING 4.4 KG.	1
<input type="checkbox"/>	8	AB.10150.46	SHOCK SPRING 4.6 KG.	1
<input type="checkbox"/>	8	AB.10150.48	SHOCK SPRING 4.8 KG.	1
<input type="checkbox"/>	8	AB.10150.50	SHOCK SPRING 5.0 KG.	1
<input type="checkbox"/>	8	AB.10150.52	SHOCK SPRING 5.2KG	1
<input type="checkbox"/>	8	AB.10150.54	SHOCK SPRING 5.4KG	1
<input type="checkbox"/>	8	AB.10150.56	SHOCK SPRING 5.6KG	1
<input type="checkbox"/>	8	AB.10150.58	SHOCK SPRING 5.8KG	1

	8	AB.10150.60	SHOCK SPRING 6.0KG	1
	8	AB.10150.62	SHOCK SPRING 6.2KG	1
	8	AB.10150.64	SHOCK SPRING 6.4KG	1
	8	AB.10150.66	SHOCK SPRING 6.6KG	1
	8	AB.10150.68	SHOCK SPRING 6.8KG	1
	9	026.330190.000	DAMPER ADJ RING NUT	1
	10	026.330120.000	SOCK ABSORBER TANK	1
	11	026.330130.000	DIAPHRAGM	1
	12	026.330140.000	PLUG	1
	13	037.330130.000	CAP	1
	14	037.330140.000	SHOCK ABSORBER BODY	1
	15	037.330150.000	SHOCK ABSORBER BODY	1
	16	031.330120.000	WASHER	1
	17	026.330210.000	BAND	1
	18	031.330140.000	WASHER	1
	19	037.330160.000	SHOCK TUBE	1
	20	037.330170.000	SEAL KIT	1
	21	026.330260.000	PLUG	1
	22	041.330028.000	SHOCK VALVE ASSY	1

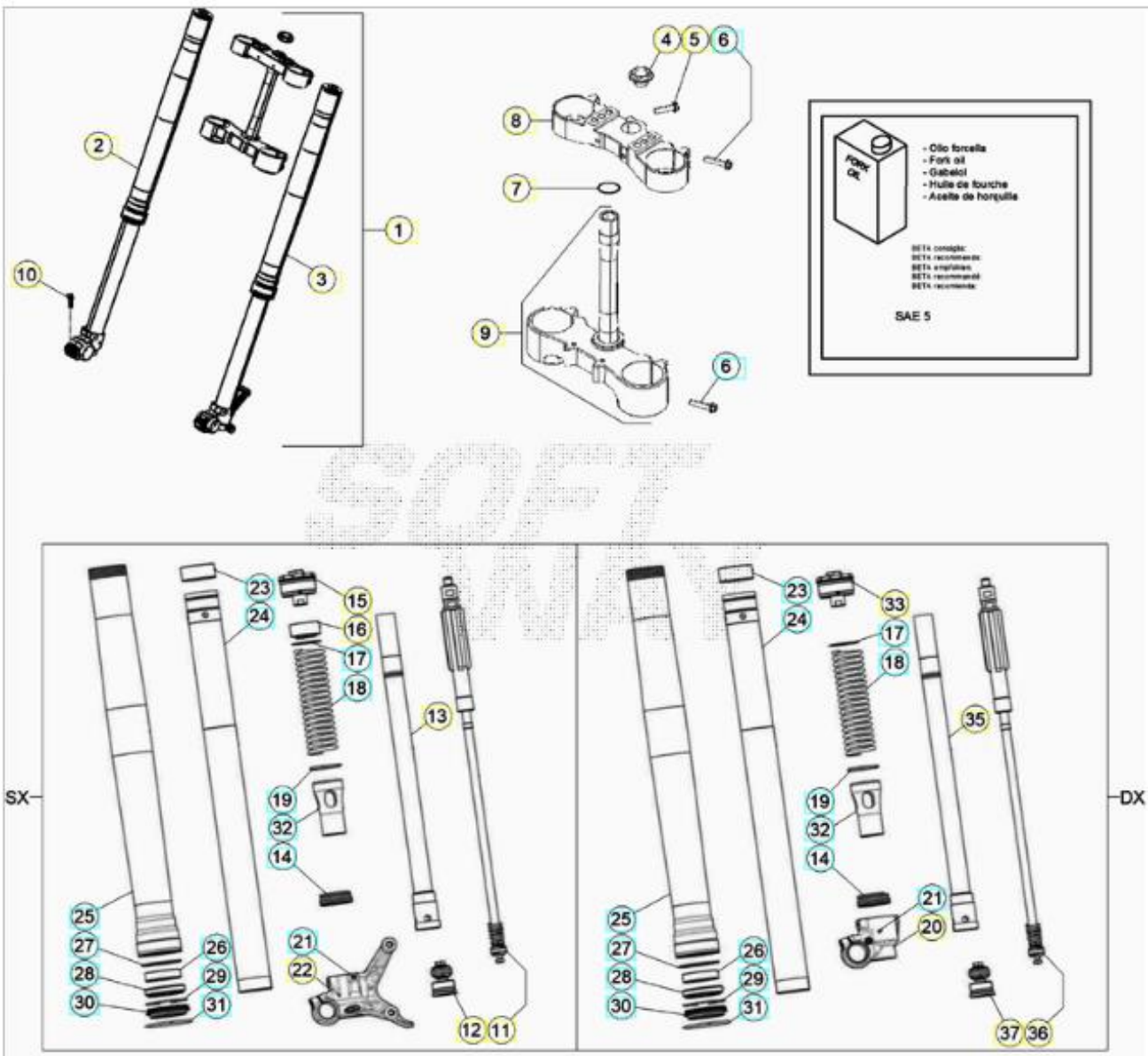







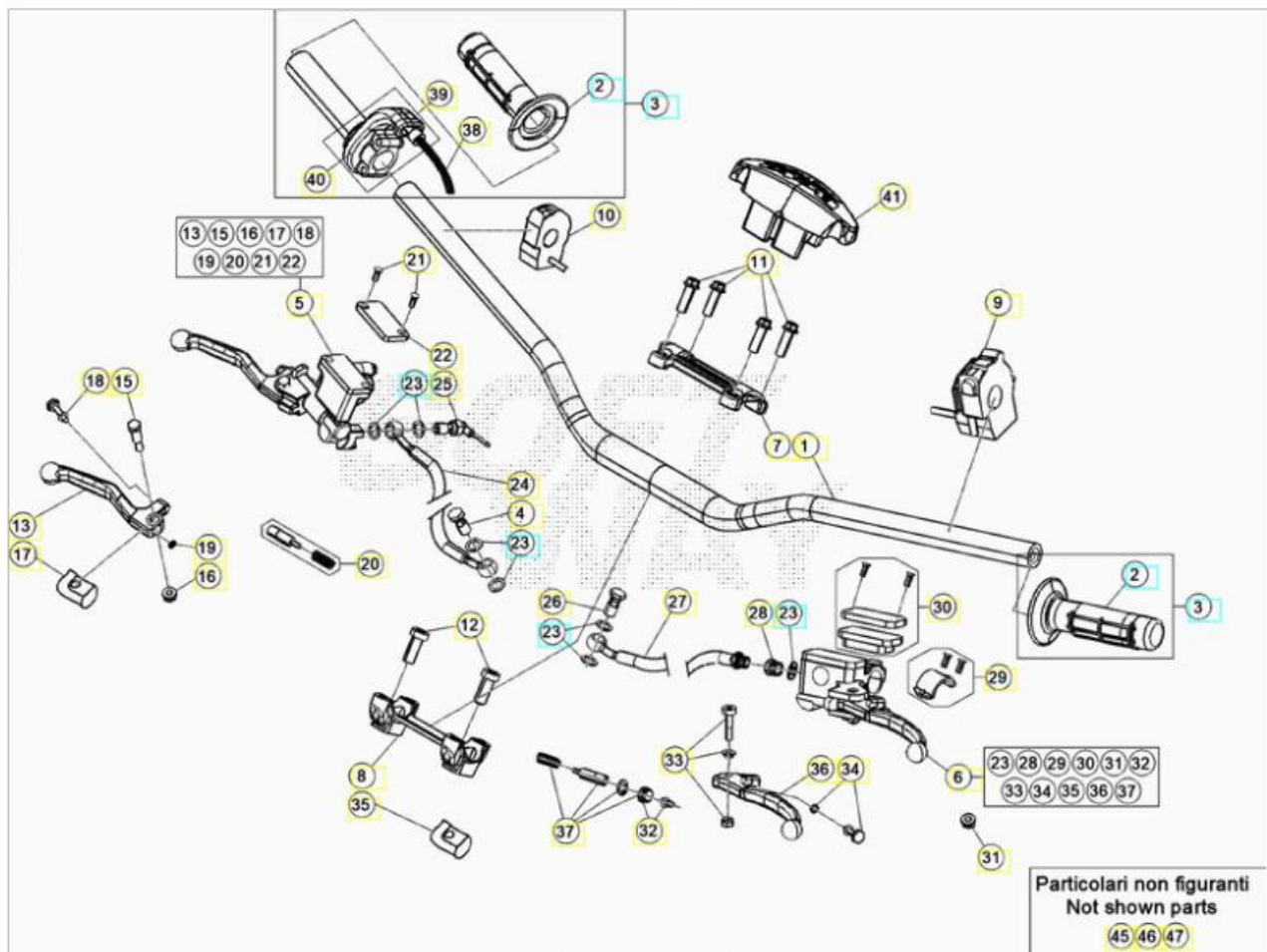









REF. NO.	PART NO.	FRONT FORK DESCRIPTION	200 RR 2T	
<input type="checkbox"/>	1	041.340028.000	FRONT FORK ORDER INDIVIDUALLY.	1
<input type="checkbox"/>	2	041.340058.000	RIGHT FORK LEG RR 2T 200	1
<input type="checkbox"/>	3	041.340068.000	LEFT FORK LEG RR 2T 200	1
<input type="checkbox"/>	4	020.340040.000	FRONT FORK 20X1,5 NUT RR 4T MY11	1
<input type="checkbox"/>	5	11.55440.000	BOLT 8.30 RS CH10	1
<input type="checkbox"/>	6	11.55510.000	BOLT 8.40	2
<input type="checkbox"/>	7	10.66420.000	O.RING 20,22.3,53 NBR	1
<input type="checkbox"/>	8	031.340514.204	TOP TRIPLE CLAMP	1
<input type="checkbox"/>	9	031.340418.204	LOWER TRIPLE CLAMP W/ STEM	1
<input type="checkbox"/>	11	041.340130.000	COMPRESSION GROUP	1
<input type="checkbox"/>	12	037.340190.000	COMPRESSION GROUP	1
<input type="checkbox"/>	13	037.340150.000	TUBE	1
<input type="checkbox"/>	14	020.343130.000	STEM SUPPORTING RING + O RING	2
<input type="checkbox"/>	15	037.340090.000	CAP	1

	16	040.340080.000	SPACER	1
	17	031.343230.000	WASHER	2
	18	026.340400.000	FORK SPRING, S/S TO AB.12048?	2
	19	020.343210.000	CENTERING RING	2
	20	037.340140.000	FORK BOTTOM	1
	21	020.343080.000	DOWEL	2
	22	037.340130.000	FORK BOTTOM	1
	23	020.343200.000	BUSH D.49/47 L20	2
	24	031.340210.000	STEM	2
	25	037.340080.000	FORK SLIDER	2
	26	031.340200.000	BUSH 52X48X12	2
	27	020.343180.000	SPACER	2
	28	020.343170.000	SKF FORK SEAL KIT . SACHS 48MM	2
	29	020.343160.000	CIRCLIP D.58,45	2
	30	020.343150.000	SKF FORK SEAL KIT . SACHS 48MM	2
	31	026.343640.000	CHECK RING	2
	32	037.340120.000	SPRING GUIDE	2
	33	037.340100.000	CAP	1
	35	037.340160.000	TUBE	1
	36	041.340140.000	COMPRESSION GROUP	1
	37	040.340110.000	COMPRESSION GROUP	1





REF. NO.	PART NO.	CONTROLS HANDLEBARS DESCRIPTION	200 RR 2T	
<input type="checkbox"/>	1	037.350000.059	HANDLEBAR BLACK	1
<input type="checkbox"/>	2	036.350050.000	BETA FACTORY GRIPS	2
<input type="checkbox"/>	2	AB.10110	BETA FACTORY GRIPS	1
<input type="checkbox"/>	3	026.350028.000	THROTTLE ASSY	2
<input type="checkbox"/>	4	11.65053.000	RR4T BRAKE TUBE M10X25 BOLT	1
<input type="checkbox"/>	5	21.02057.059	FRONT BRAKE LEVER, RACING	1
<input type="checkbox"/>	6	020.350200.000	CLUTCH LEVER, RR 4T	1
<input type="checkbox"/>	7	12.08253.000	UPPER HANDLEBAR BRACKET, FORK 15.08	1
<input type="checkbox"/>	8	12.08263.000	LOWER HANDLEBAR BRACKET, FORK 15.08	1
<input type="checkbox"/>	9	016.350100.000	DEVICE, RR 4T	1
<input type="checkbox"/>	10	026.400470.000	ON/OFF DEVICE	1
<input type="checkbox"/>	11	31.64070.000	SCREW 8.30	1
<input type="checkbox"/>	12	31.65626.000	SCREW TCCE M10.25 SPECIAL HEAD	1
<input type="checkbox"/>	13	21.27104.000	FRONT BRAKE LEVER ONLY (2102057)	2
<input type="checkbox"/>	15	31.96832.000	RR4Y BRAKE LEVER SPECIAL SCREW	2
<input type="checkbox"/>	16	13.30911.000	SPECIAL NUT BRAKE LEVER RR4T	2
<input type="checkbox"/>	17	16.33841.000	GROMMET	2
<input type="checkbox"/>	18	31.88604.000	BRAKE LEVER ADJ. SCREW	2
<input type="checkbox"/>	19	22.38704.000	FRONT BRAKE LEVER RETURN SPRING	2

	20	20.08258.000	BRAKE PUMP PISTON ASSY	2
	21	31.23410.052	SCREW	2
	22	031.360038.200	BRAKE PUMP COVER	2
	23	16.50510.000	GASKET 10.15.1 COPPER	5
	24	037.360020.000	BRAKE HOSE	1
	25	18.89621.000	STOP SWITCH, M10 X 1,25	1
	26	11.65040.000	SPECIAL BOLT	1
	27	035.350020.000	CLUTCH TUBE	1
	28	020.350320.000	JOINT.P.	2
	29	020.350250.000	CLAMP	2
	30	020.350230.000	RESERVOIR CAP	2
	31	020.350280.000	ANTI.BUBBLE	2
	32	020.350290.000	PUSH.ROD	2
	33	020.350240.000	LEVER PIN	2
	34	020.350300.000	SPRING GUIDE	2
	35	020.350270.000	DUST COVER	2
	36	020.350220.000	LEVER	2
	37	020.350260.000	PISTON SET	2
	38	026.350118.200	THROTTLE CABLE, RR 2.STROKE	1
	39	026.350100.000	THROTTLE ASSEMBLY	1
	40	031.350130.000	PROTECTION	1
	41	037.430160.059	HANDLEBAR PROTECTION BLACK RR	1
	45	12.30100.000	HOLDER WITH MIRROR CONNECTION	1
	46	28.92927.000	RH MIRROR	1
	47	031.350080.000	MIRROR	1



- Olio freni  
- Brake fluid  
- Bremsflüssigkeit  
- Liquide de frein  
- El líquido de frenos







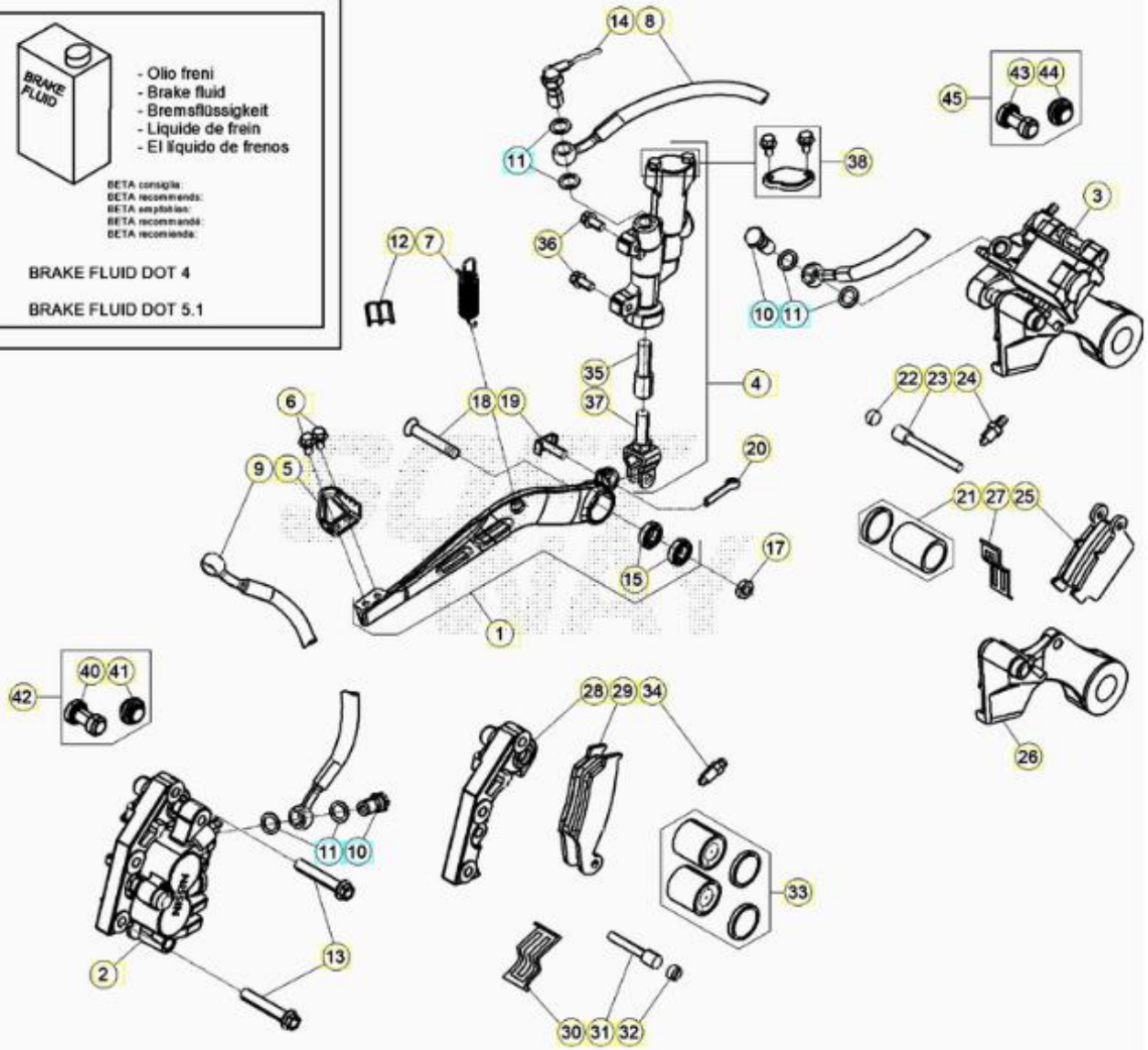





















BETA consiglia:  
BETA recommends:  
BETA empfiehlt:  
BETA recomandă:  
BETA recomienda:

BRAKE FLUID DOT 4

BRAKE FLUID DOT 5.1



REF. NO.	PART NO.	HYDRALIC BRAKE SYSTEM DESCRIPTION	200 RR 2T	
<input type="checkbox"/>	1	037.360048.000	FOOT BRAKE LEVER	1
<input type="checkbox"/>	2	25.03056.000	FRONT DISC BRAKE CALIPER, RR 4T	1
<input type="checkbox"/>	3	25.03066.000	REAR DISC BRAKE CALIPER, RR 4T	1
<input type="checkbox"/>	4	25.91178.000	PUMP, REAR BRAKE	1
<input type="checkbox"/>	5	22.90053.000	FOOTREST HUB, RR 4T	1
<input type="checkbox"/>	6	11.46251.000	BOLT 5,12	1
<input type="checkbox"/>	7	026.360000.000	SPRING	1
<input type="checkbox"/>	8	29.09428.000	REAR BRAKE HOSE, RR 4T '07	1
<input type="checkbox"/>	9	037.360020.000	BRAKE HOSE	1
<input type="checkbox"/>	10	11.65053.000	RR4T BRAKE TUBE M10X25 BOLT	2
<input type="checkbox"/>	11	16.50510.000	GASKET 10.15.1 COPPER	3
<input type="checkbox"/>	12	25.24442.000	FAIR LEAD, 6/8	1
<input type="checkbox"/>	13	11.55510.000	BOLT 8.40	1
<input type="checkbox"/>	14	18.89621.000	STOP SWITCH, M10 X 1,25	1

	15	C06010470000	BEARING 10X26X8 . 2RSH	1
	17	13.21060.000	NUT, M10X1,25 H.8.5 14MM SELF.LOCKI	1
	18	037.360010.000	SPECIAL BOLT M10X1,25X35	1
	19	25.41830.000	PIN	1
	20	12.81995.000	CLIP 2.15 INOX	1
	21	20.02717.000	PISTON & OIL SEAL KIT FOR PLIERS 25	1
	22	31.96821.000	PIN PLUG, FOR 2503056/2503066	2
	23	25.41860.000	PIN HANGER, FOR 25.03066.000	1
	24	28.91002.000	BREATHER PIPE	1
	25	25.25362.000	BRAKE PADS	1
	26	020.360110.000	REAR BRAKE CALIPER BRACKET ASSY	1
	27	22.32208.000	BRAKE PADS SPRING FOR PLIERS	1
	28	020.360120.000	FRONT BRAKE CALIPER BRACKET ASSY	1
	29	25.25361.000	FR BRAKE PADS	1
	29	25.25365.000	FR BRAKE PADS	1
	30	22.32207.000	BRAKE PADS SPRING FOR PLIERS	1
	31	25.41859.000	PIN HANGER, FOR 25.03056.000	1
	33	20.02716.000	PISTON & OIL SEAL KIT FOR PLIERS 25	1
	34	28.91001.000	BREATHER PIPE	1
	35	20.08276.000	KIT PISTON, BRAKE PUMP 25.91178	1
	36	31.30750.000	SCREW 6.16	1
	37	20.08277.000	KIT LEVER, BRAKE PUMP 25.91178	1
	38	20.08275.000	KIT, BRAKE PUMP TANK 25.91178	1
	40	036.360020.000	BUSHING	1
	41	036.360030.000	BUSHING	1
	42	036.360068.200	FRONT BUSHING KIT	1
	43	036.360040.000	BUSHING	1
	44	036.360050.000	BUSHING	1
	45	036.360078.200	REAR BUSHING KIT	1

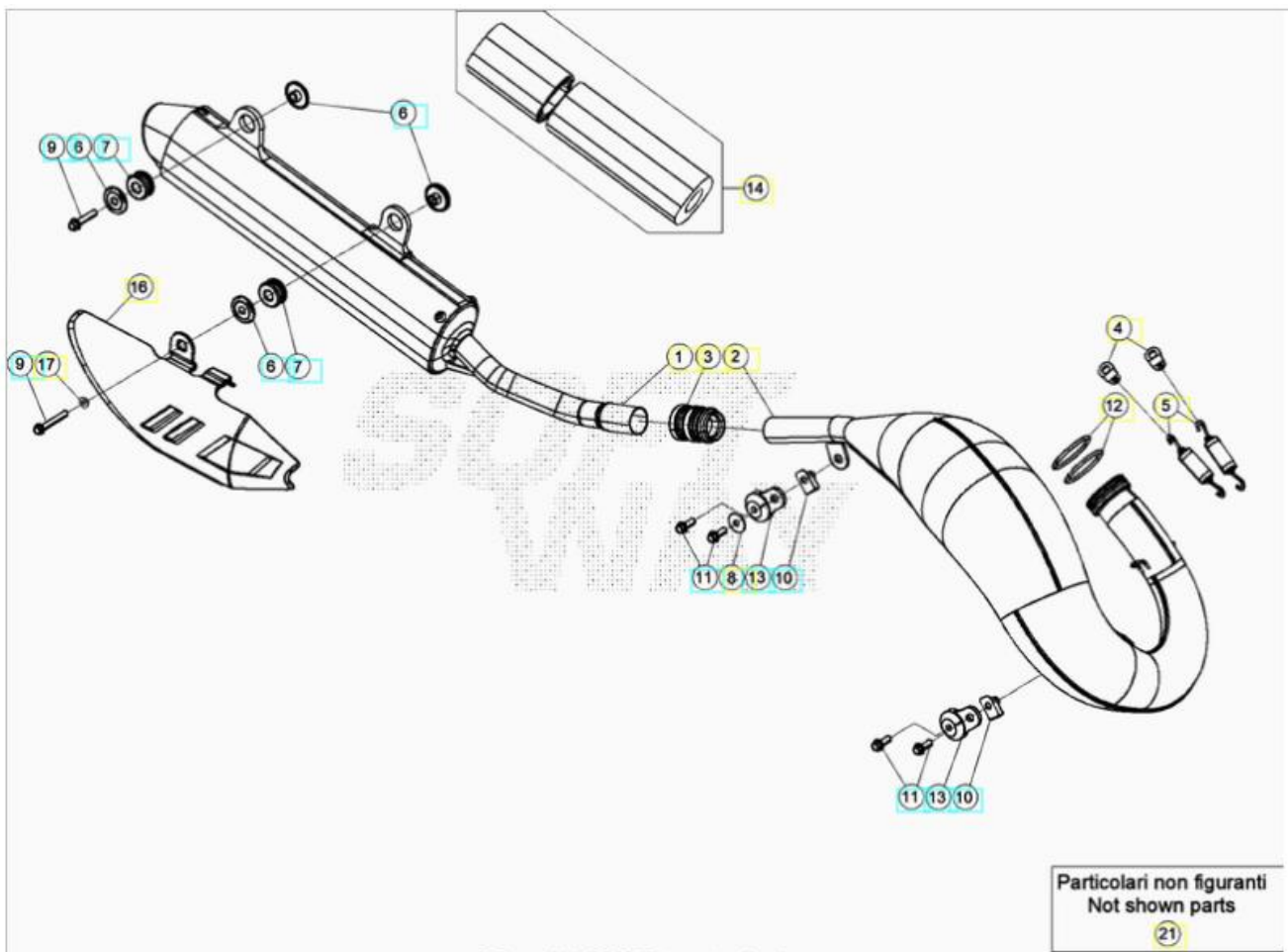

REF. NO.	PART NO.	EXHAUST SYSTEM DESCRIPTION	200 RR 2T	
<input type="checkbox"/>	1	040.370008.200	SILENCER 200/250 RR	1
<input type="checkbox"/>	2	035.370228.000	EXHAUST, 200CC	1
<input type="checkbox"/>	3	026.371030.000	EXHAUST GASKET	1
<input type="checkbox"/>	4	25.57912.000	RETAINING PLATE	1
<input type="checkbox"/>	5	026.370050.000	SPRING, EXHAUST PIPE RR 2T	1
<input type="checkbox"/>	6	026.370060.000	SPACER	3
<input type="checkbox"/>	7	032.370130.000	EXHAUST PIPE SILENT BLOCK	2
<input type="checkbox"/>	8	27.42000.000	WASHER 6.18	1
<input type="checkbox"/>	9	11.50300.000	BOLT 6.30 RS CH8	2
<input type="checkbox"/>	10	25.60311.000	M6 SCREW PLATE	2
<input type="checkbox"/>	11	11.48025.000	BOLT 6.16	2
<input type="checkbox"/>	12	10.66930.000	OIL SEAL OR 43,00.3,00	1
<input type="checkbox"/>	13	28.91943.000	SILENT.BLOCK	2
<input type="checkbox"/>	14	036.371108.200	KIT FOR SILENCER OVERHAULING	1
<input type="checkbox"/>	14	026.370078.200	KIT FOR SILENCER OVERHAULING	1
<input type="checkbox"/>	16	040.370028.259	SILENCER GUARD BLACK RR 2T	1
<input type="checkbox"/>	17	13.54841.000	SPACER 6,5/10,0/16,0 . 4,3	1
<input type="checkbox"/>	21	035.370278.000	EXHAUST RR 2T 200 EU	1

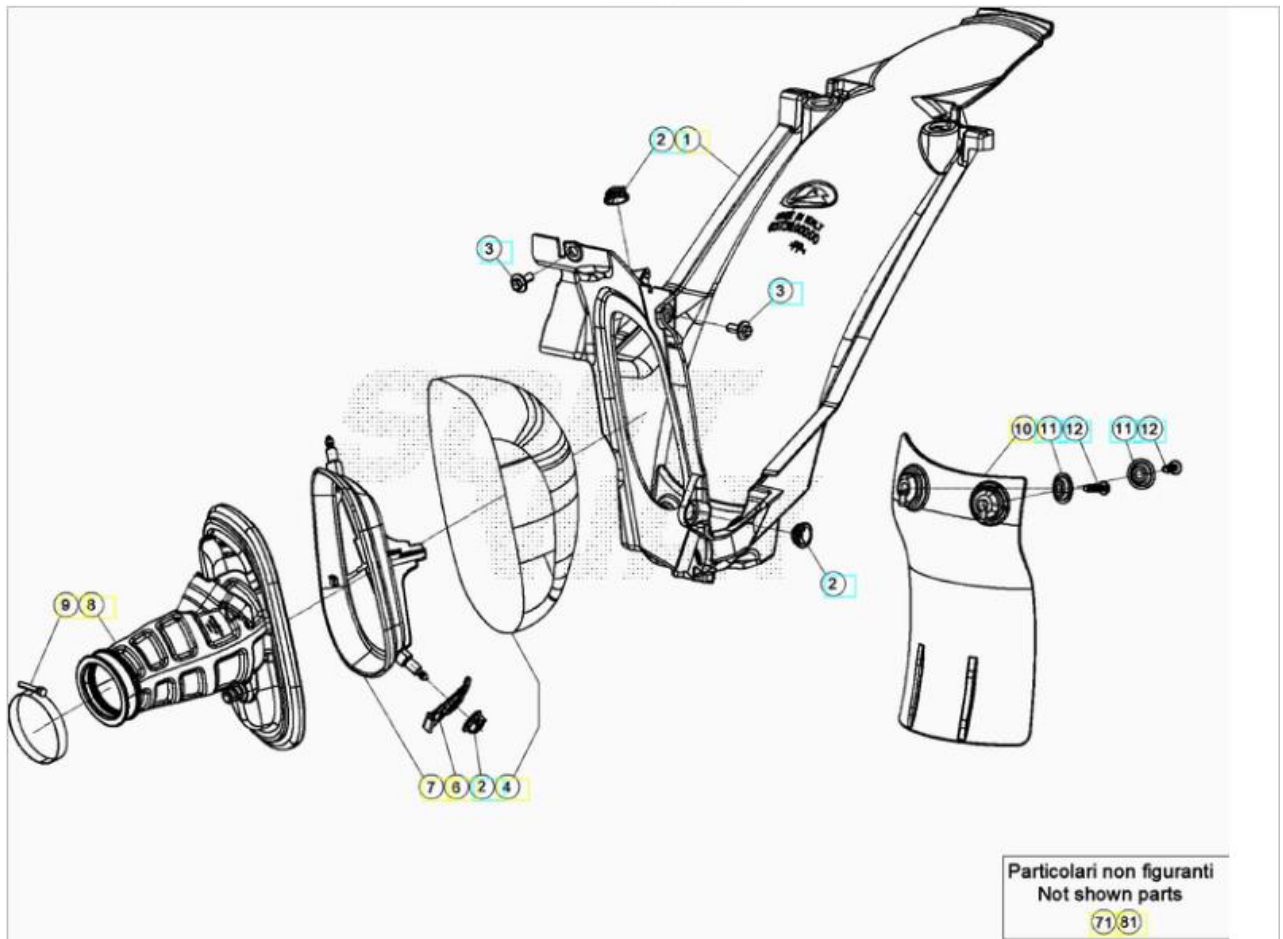

REF. NO.	PART NO.	AIR BOX DESCRIPTION	200 RR 2T	
<input type="checkbox"/>	1	037.380008.759	AIRBOX BLACK RR	1
<input type="checkbox"/>	2	037.380030.000	INSERT 2T	3
<input type="checkbox"/>	3	037.430290.000	SPECIAL BOLT M6X12	2
<input type="checkbox"/>	4	037.380028.200	AIR FILTER	1
<input type="checkbox"/>	6	037.380060.059	AIR BOX BRACKET BLACK RR	1
<input type="checkbox"/>	7	037.380010.000	AIR FILTER CAGE 2T	1
<input type="checkbox"/>	8	007.380021.400	AIR BOX	1
<input type="checkbox"/>	9	15.14272.000	CLAMP	1
<input type="checkbox"/>	10	026.380071.059	PROTECTION REAR SHOCK	1
<input type="checkbox"/>	11	27.74786.000	WASHER	2
<input type="checkbox"/>	12	31.30815.000	SCREW 6.20	2
<input type="checkbox"/>	71	037.380080.000	AIR FILTER CAGE 2T	1
<input type="checkbox"/>	81	041.380000.000	AIRBOX SLEEVE RR 2T	1

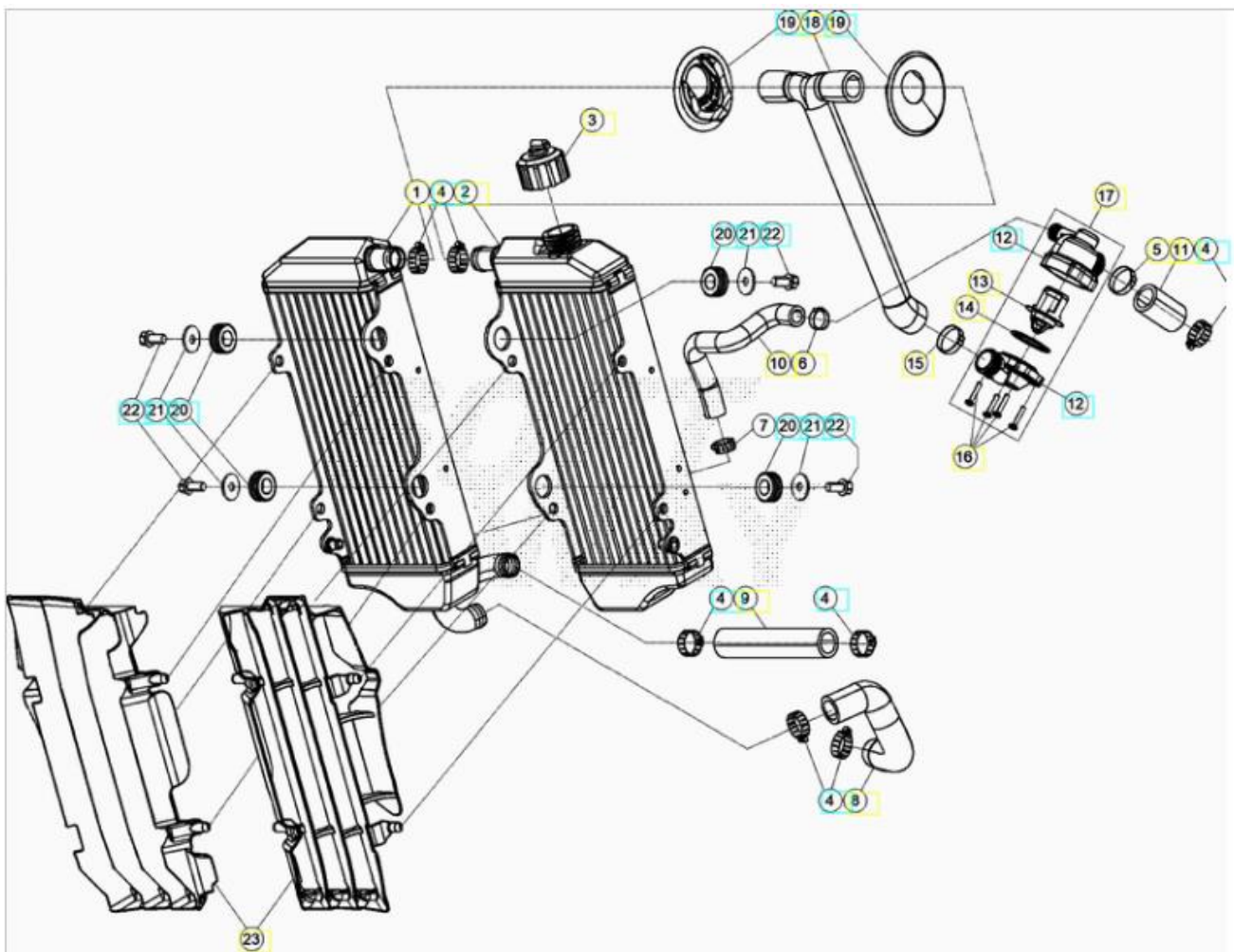

REF. NO.	PART NO.	COOLING SYSTEM DESCRIPTION	200 RR 2T	
<input type="checkbox"/>	1	040.390010.000	RADIATOR 2T RIGHT (ALT)	1
<input type="checkbox"/>	1	040.390180.000	RADIATOR 2T RIGHT	1
<input type="checkbox"/>	2	040.390190.000	RADIATOR 2T LEFT	1
<input type="checkbox"/>	3	036.390080.000	RADIATOR CAP	1
<input type="checkbox"/>	4	15.15240.000	CLAMP 16/27	5
<input type="checkbox"/>	5	C07160050000	CLAMP D.25	1
<input type="checkbox"/>	6	020.390090.000	SELF LOCKING CLAMP, 17	1
<input type="checkbox"/>	7	15.15220.000	CLAMP	1
<input type="checkbox"/>	8	041.390030.000	WATER PUMP HOSE RR 2T	1
<input type="checkbox"/>	9	040.390070.000	WATER HOSE RR 2T	1
<input type="checkbox"/>	10	040.390080.000	WATER HOSE RR 2T	1
<input type="checkbox"/>	11	041.390020.000	WATER HOSE RR 2T 200	1
<input type="checkbox"/>	12	037.390060.000	THERMOSTAT CASE RR	2
<input type="checkbox"/>	13	026.390130.000	TERMOSTAT RR TS	1
<input type="checkbox"/>	14	10.66830.000	O.RING	1
<input type="checkbox"/>	15	C07160070000	TIE WRAP D26	1
<input type="checkbox"/>	16	031.390175.000	SCREW	1
<input type="checkbox"/>	17	040.390038.000	THERMOSTAT RR 2T	1

<input type="checkbox"/>	18	041.390000.000	WATER HOSE	1
<input type="checkbox"/>	19	037.390150.000	CAP	2
<input type="checkbox"/>	20	035.390060.000	SILENT BLOCK	3
<input type="checkbox"/>	21	27.43250.000	WASHER 6.24	3
<input type="checkbox"/>	22	11.47015.000	BOLT 6.12 RS CH8	3
<input type="checkbox"/>	23	037.390030.051	RADIATOR LOUVER PAIR WHITE RR	1

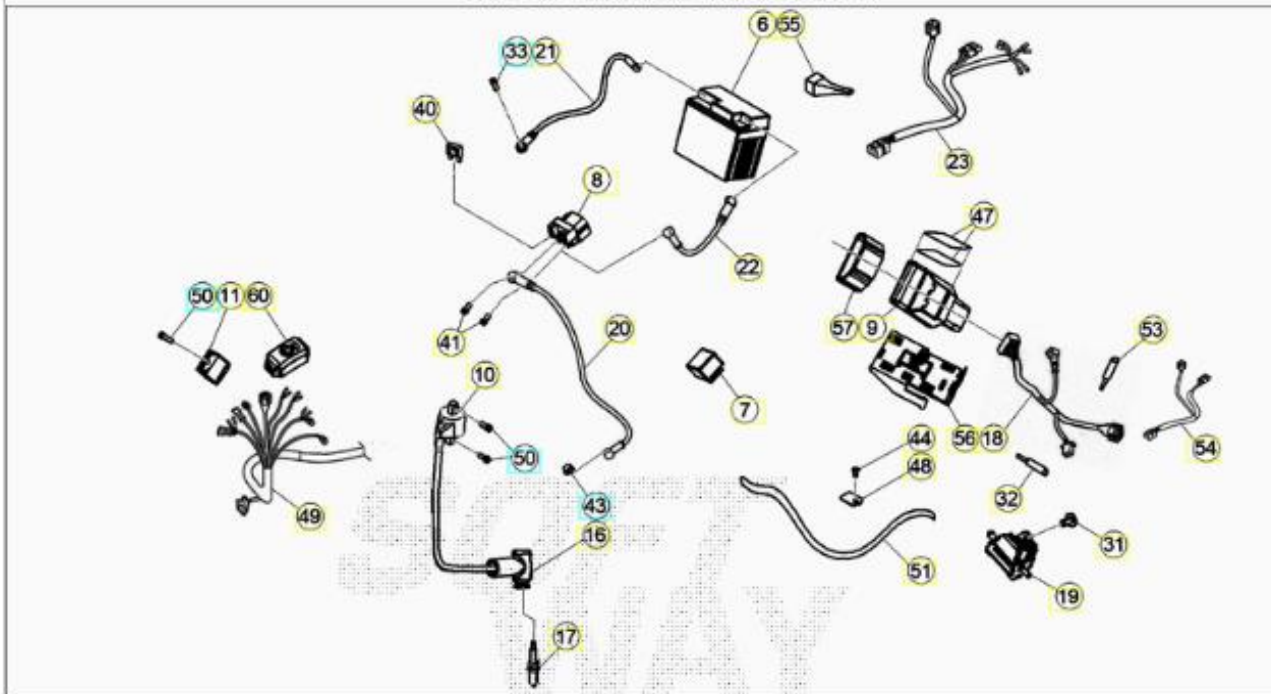

GR. LUCI/INDICATORI

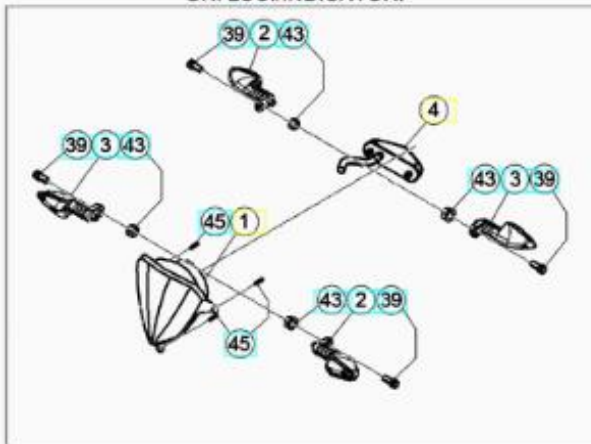

GR. STRUMENTAZIONE

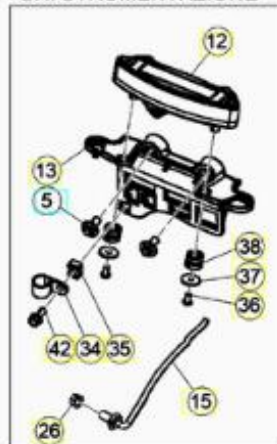

GR. AVV. ACUSTICO





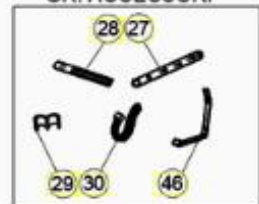

































GR. ACCESSORI



REF. NO.	PART NO.	ELECTRICAL EQUIPMENT DESCRIPTION	200 RR 2T	
<input type="checkbox"/>	1	031.400060.000	HEADLIGHT, RR 4T '08	1
<input type="checkbox"/>	1	16.46210.000	HEADLIGHT, RR 4T '08	1
<input type="checkbox"/>	2	020.400610.000	BLINKER LF/RR	2
<input type="checkbox"/>	3	020.400600.000	BLINKER RF/LR	2
<input type="checkbox"/>	4	037.400630.000	TAIL LIGHT	1
<input type="checkbox"/>	5	037.430280.000	SPECIAL BOLT M6X8	3
<input type="checkbox"/>	6	AB.62009	BATTERY	1
<input type="checkbox"/>	7	18.84948.000	FLASHING DEVICE	1
<input type="checkbox"/>	8	27.28471.000	RELAIS, STARTING	1



	9	041.400028.200	CDI, 2020 200RR	1
	10	007.400440.000	IGNITION COIL	1
	11	27.28101.000	RECTIFIER	1
	12	040.400040.000	DIGITAL DASHBOARD RR 2T	1
	13	037.400010.000	DASHBOARD BRACKET RR	1
	14	007.400500.000	HORN	1
	15	031.401660.000	REED SENSOR	1
	16	27.13514.000	SPARK PLUG PROTECTOR CR65.2001	1
	17	12.25123.000	SPARKPLUG, BR8ECM	1
	18	040.400000.000	MAIN WIRING HARNESS RR 2T	1
	19	026.400170.000	OIL PUMP	1
	20	026.400060.000	STARTER SYSTEM RRTS	1
	21	020.400020.000	RR4T MY'10 GROUND WIRING SYSTEM	1
	22	037.400070.000	RELAY WIRING HARNESS	1
	23	040.400060.000	SECONDARY WIRING HARNESS RR 2T	1
	24	037.400230.059	HORN BRACKET BLACK RR	1
	25	25.60311.000	M6 SCREW PLATE	1
	26	13.17121.000	NUT M8, SPECIAL CH.10	1
	27	037.400260.000	TIE WRAP	1
	28	032.350490.000	TIE WRAP	1
	29	25.24443.000	FAIR LEAD, 6/6	1
	30	15.14264.000	S/S TO 037.400260.000	1
	30	037.400260.000	TIE WRAP	1
	31	31.95510.000	SCREW 6X12 TBCE	1
	32	026.400390.000	CONNECTOR	1
	33	11.46501.000	BOLT 6.10	2
	34	25.25182.000	CLAMP "NYLPAS016R"	1
	35	037.400300.000	DISCONTINUED	1
	36	31.73000.000	SCREW 4.8	1
	37	27.34800.000	WASHER 4.16	1
	38	031.400130.000	RUBBER BUFFER	1
	39	11.48025.000	BOLT 6.16	4
	40	020.400060.000	10/32V FUSE	1
	41	31.30190.000	SCREW 6.8	1
	42	11.46251.000	BOLT 5,12	1
	43	13.12550.000	NUT M6	5
	44	31.23360.000	SCREW 4.10	1

	45	31.26190.000	SCREW 4.12	2
	46	037.430430.000	BATTERY RUBBER BAND	1
	47	29.10317.000	RUBBER, BUMBER RR 4T	1
	48	029.070250.000	STARTER GEAR PLATE	1
	49	040.400030.000	SECONDARY WIRING HARNESS RR 2T	1
	50	11.49070.000	BOLT 6.20	2
	51	026.430270.000	OIL TUBE	1
	53	037.400220.000	CAPACITOR	1
	54	026.400570.000	DIAGNOSIS WIRING	1
	55	031.400520.000	DIODE	1
	56	040.400010.000	ECU BRACKET RR.S 2T	1
	57	007.400810.000	ECU RUBBER BAND	1
	60	007.400880.000	ECU MAP SWITCH B1	1



REF. NO.	PART NO.	WHEEL . FRONT DESCRIPTION	200 RR 2T	
	1	031.410460.059	FRONT RIM	2
	2	15.38200.000	BEAD 21.25	2
	5	031.410300.000	FRONT BRAKE DISC	1
	5	031.410308.200	FRONT BRAKE DISC	1
	6	020.410070.000	PLUG, FRONT WHEEL SPINDLE RR 4T MY'	1
	7	031.410040.000	HUB SPACER, RR 4T	2
	8	10.66000.000	SEAL 35.47.7	2
	9	020.410030.000	BEARING 30.47.9	2
	10	020.410050.000	FRONT WHEEL SPINDLE, RR 4T MY'11	1
	11	031.410150.000	INNER SPACER	1
	12	020.411100.000	PLUG	1
	13	020.410060.000	PLUG, FRONT WHEEL SPINDLE RR 4T MY'	1
	14	031.410160.000	DISC SPEC. SCREW 6X14	1
	14	031.410430.000	DISC SPEC. SCREW 6X14	1
	15	28.22660.000	SEEGER 9E	1
	16	021.410050.000	MAGNETE, HALL SENSOR	1
	17	031.410500.000	NIPPLE	2
	18	031.410490.052	SPOKE	2
	19	27.58080.000	WASHER 9 . 13 . 0,4	1
	20	036.410100.000	RIM LOCK	2
	21	13.17120.000	NUT M8	2
	22	026.410010.059	FR WHEEL ASSY	1
	23	031.410148.000	FRONT HUB, RR 4T	2
	24	C01260010000	CIRCLIP 47X1.75	1

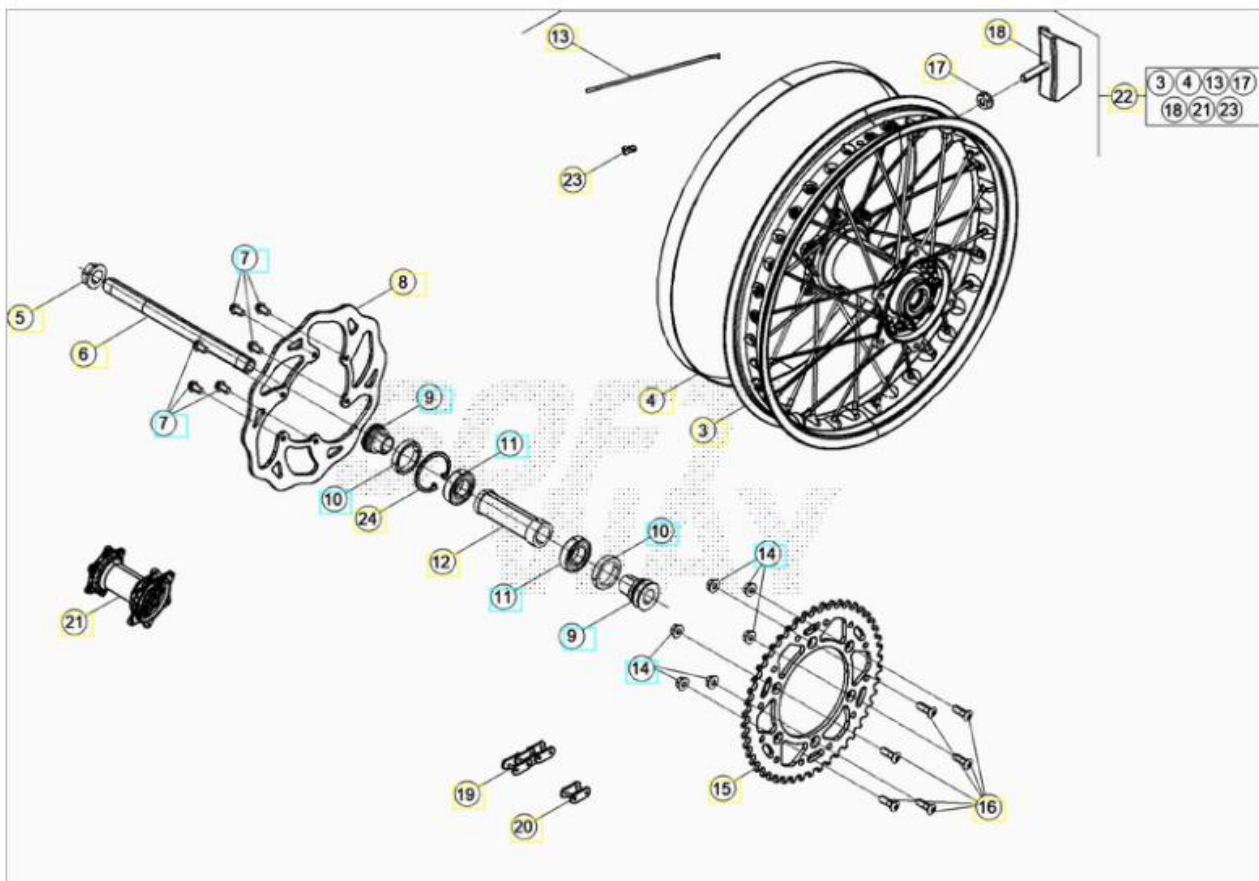



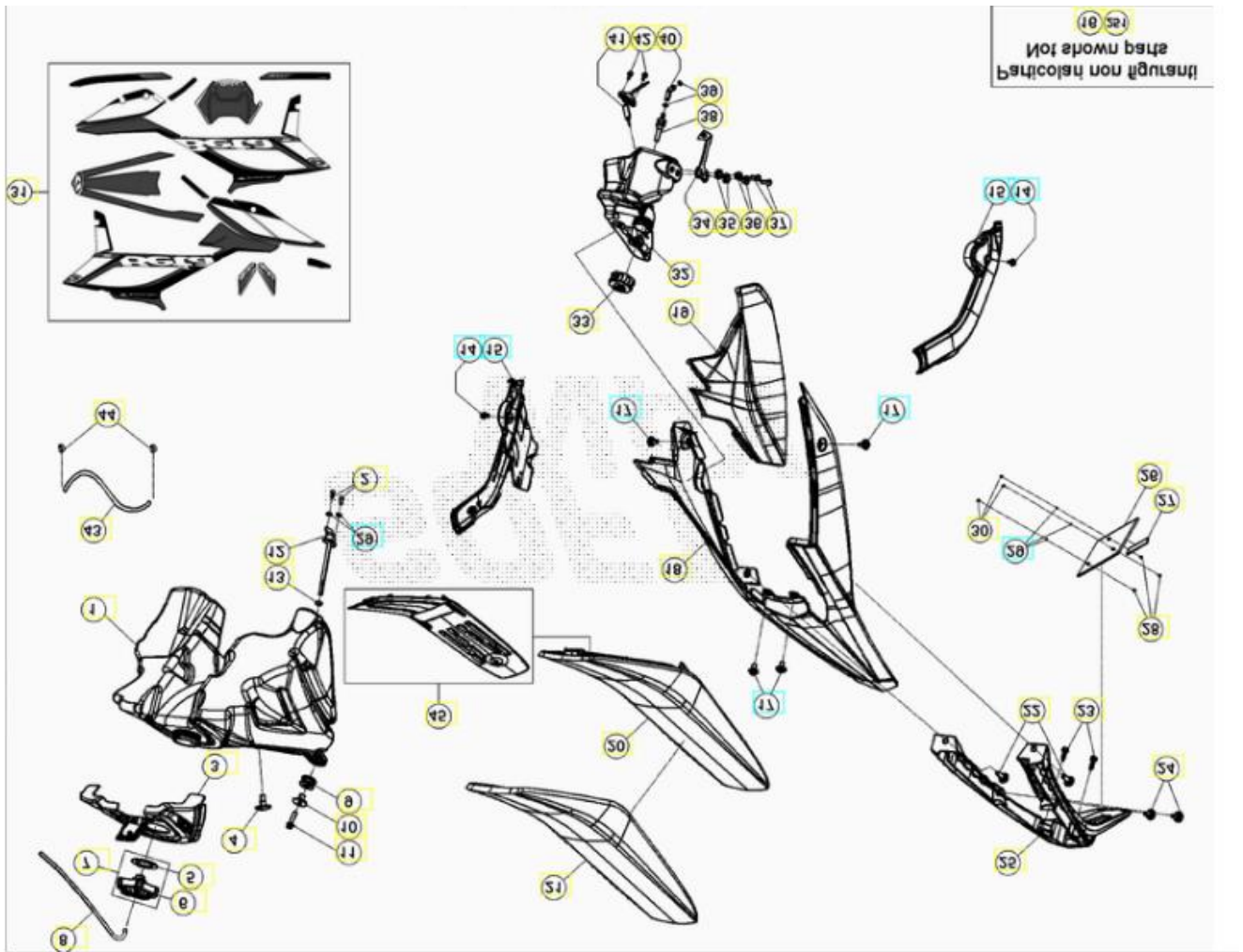

REF. NO.	PART NO.	WHEEL . REAR DESCRIPTION	200 RR 2T	
<input type="checkbox"/>	3	031.420340.059	REAR RIM	2
<input type="checkbox"/>	4	15.36000.000	BEAD 17/18.25	2
<input type="checkbox"/>	5	13.27120.000	SPECIAL NUT	1
<input type="checkbox"/>	6	25.55812.000	REAR WHEEL SPINDLE, RR 4T	1
<input type="checkbox"/>	7	031.410160.000	DISC SPEC. SCREW 6X14	2
<input type="checkbox"/>	7	031.410430.000	DISC SPEC. SCREW 6X14	1
<input type="checkbox"/>	8	031.420300.000	BRAKE DISC	1
<input type="checkbox"/>	8	031.420308.200	BRAKE DISC	1
<input type="checkbox"/>	9	031.420020.000	REAR HUB SPACER, RR 4T	2
<input type="checkbox"/>	10	10.66000.000	SEAL 35.47.7	2
<input type="checkbox"/>	11	020.420040.000	BEARING 25.47.12	2
<input type="checkbox"/>	12	031.420050.000	INNER SPACER	1
<input type="checkbox"/>	13	031.420370.052	REAR SPOKES	2
<input type="checkbox"/>	14	13.17123.000	NUT M8, (DIN 6927)	2
<input type="checkbox"/>	16	31.96827.000	SCREW, SPEC. TGS TORXS M8X26	1
<input type="checkbox"/>	17	13.17120.000	NUT M8	2
<input type="checkbox"/>	18	036.420090.000	RIM LOCK	2
<input type="checkbox"/>	19	037.420010.000	CHAIN 5/8 1/4 P.116	1
<input type="checkbox"/>	20	031.420080.000	CONNECTING LINK	1
<input type="checkbox"/>	21	031.420148.000	REAR HUB, RR4T	2

<input type="checkbox"/>	22	026.420080.059	REAR WHEEL ASSY	1
<input type="checkbox"/>	23	031.420510.000	NIPPLE	2
<input type="checkbox"/>	24	C01260010000	CIRCLIP 47X1.75	1



REF. NO.	PART NO.	FAIRING . TANK . SEAT DESCRIPTION	200 RR 2T	
<input type="checkbox"/>	1	040.430000.051	FUEL TANK WHITE RR 2T	1
<input type="checkbox"/>	2	31.29810.000	SCREW 5.12	1
<input type="checkbox"/>	3	041.430000.059	COVER	1
<input type="checkbox"/>	4	31.89010.000	SPECIAL SCREW	1
<input type="checkbox"/>	5	031.431160.000	CAP GASKET	1
<input type="checkbox"/>	6	036.430418.000	FILLER CAP	1
<input type="checkbox"/>	6	036.430418.200	FILLER CAP	2
<input type="checkbox"/>	8	020.430030.000	EXHAUST TUBE PLUG/VALVE RR 4T MY'10	1
<input type="checkbox"/>	9	032.370130.000	EXHAUST PIPE SILENT BLOCK	1
<input type="checkbox"/>	10	020.430020.000	SPACER, FUEL TANK RR 4T MY'10	1
<input type="checkbox"/>	11	11.50300.000	BOLT 6.30 RS CH8	1
<input type="checkbox"/>	12	020.430070.000	PETCOCK, RR 4T MY'10	1
<input type="checkbox"/>	13	026.430340.000	OIL SEAL	1
<input type="checkbox"/>	14	C24310460000	SCREW M5X8 8.8 DIN6921	2

	15	037.430780.059	FRAME GUARD . PAIR BLACK RR	2
	16	041.430088.200	ACTIVATED CARBON FILTER BOX . KIT 2T	1
	17	037.430280.000	SPECIAL BOLT M6X8	3
	18	037.430078.797	REAR FENDER RED RR	1
	19	037.430058.797	SIDE PANEL RED RR	1
	20	037.430638.200	SEAT	1
	21	037.430858.200	SEAT COVER RR	1
	22	037.430300.000	SPECIAL BOLT M6X16	1
	23	31.79960.000	SCREW, 6X15	1
	24	037.430290.000	SPECIAL BOLT M6X12	1
	25	037.430140.059	TAILLIGHT HOLDER BLACK RR	1
	26	018.430101.059	DISCONTINUED . EURO ONLY	1
	27	12.33086.000	DISCONTINUED	1
	28	31.29860.000	SCREW 5.16	1
	29	27.36000.000	WASHER 5.11	2
	30	13.11010.000	NUT 5, SELF.BLOCKING NUT 5	1
	31	037.430718.200	DECALS . FULL SET	1
	32	040.430010.051	OIL TANK RR 2T	1
	33	040.430040.000	OIL TANK CAP	1
	34	040.430020.000	BRACKET	1
	35	28.91880.000	SILENT.BLOCK	1
	36	13.62000.000	SPACER	1
	37	31.30470.000	SCREW 6.14	1
	38	036.430170.000	JOINT	1
	39	C07160060000	TIE WRAP D9	1
	40	036.430220.000	OIL LINE	1
	41	040.400050.000	LEVEL SENSOR	1
	42	11.47015.000	BOLT 6.12 RS CH8	1
	43	026.430050.000	GASOLINE TUBE TANK/CARBUR. RR 2T	1
	44	C07080080000	RING CE 12	1
	45	037.430848.000	SEAT PAN	1
	251	037.430150.059	TAILLIGHT/LICENSE PLATE HOLDER, RR.S	1

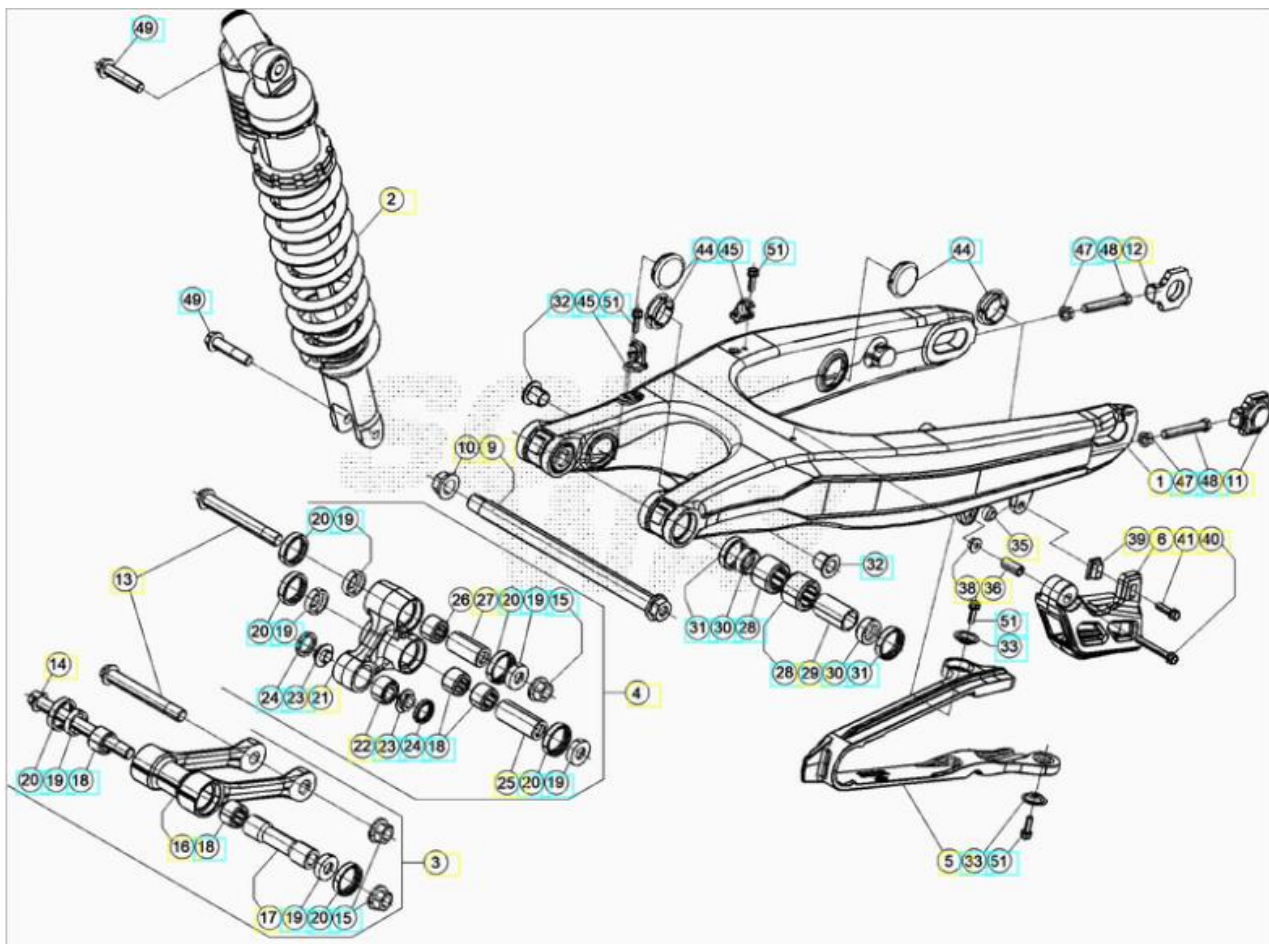

REF. NO.	PART NO.	REAR FORK DESCRIPTION	200 RR 2T	
<input type="checkbox"/>	1	037.330030.059	SWINGARM BLACK RR	1
<input type="checkbox"/>	2	041.330018.000	SHOCK ABSORBER RR 2T 200	1
<input type="checkbox"/>	3	020.330308.000	CONNECTING ROD ASSY	1
<input type="checkbox"/>	4	020.330208.000	RELAY ARM ASSY	1
<input type="checkbox"/>	5	037.330060.000	CHAIN SLIDING PROTECTION	1
<input type="checkbox"/>	6	037.330040.000	CHAIN GUIDE	1
<input type="checkbox"/>	9	037.330055.000	SWINGARM PIVOT BOLT	1
<input type="checkbox"/>	10	037.330085.000	NUT	1
<input type="checkbox"/>	11	29.11866.100	LEFT CHAIN TIGHTENER, RR 4T	1
<input type="checkbox"/>	12	29.11865.100	RIGHT CHAIN TIGHTENER, RR 4T	1
<input type="checkbox"/>	13	11.63992.000	BOLT 12 . 1,25 . 96	1
<input type="checkbox"/>	14	020.330320.000	SPECIAL SCREW M12 X 1.25 X 124	1
<input type="checkbox"/>	15	13.21130.000	SELF.BLOCKING NUT 12.1,25	2
<input type="checkbox"/>	16	020.330300.000	CONNECTING ROD ASSY	1
<input type="checkbox"/>	17	020.330310.000	SPACER, CONNECTING ROD	1
<input type="checkbox"/>	18	11.22055.000	BEARING, 20 X 26 X 16 RR 4T	3
<input type="checkbox"/>	19	28.14083.000	ROCKING LEVER CUP, RR 4T	6
<input type="checkbox"/>	20	10.64481.000	OIL SEAL, 25X32X7	8
<input type="checkbox"/>	21	020.330200.000	RELAY ARM MACHINED	1

	22	16.17310.000	SEAL 24.12.13	1
	23	11.21920.000	BUSH	2
	24	10.56020.000	OIL SEAL 16.24.4	2
	25	13.62813.000	SPACER, 12 X 20 X 50	1
	26	11.22061.000	SEAL, 20 X 26 X 30	1
	27	13.62812.000	SPACER, 12 X 20 X 40	1
	28	11.22056.000	ROLLER CAGE	2
	29	13.49183.000	SPACER, SWINGING ARM VEM	1
	30	28.14081.000	RR4T SWINGING ARM PART	2
	32	020.330010.000	SWINGINGARM BUSH, RR 4T MY'10	2
	33	27.74786.000	WASHER	2
	35	13.12610.000	NUT, SPECIAL	1
	36	13.49191.000	SPACER	1
	38	13.13020.000	NUT 6, SELF.BLOCKING	1
	39	13.48868.000	SPACER	1
	40	11.50535.000	BOLT 6,45	1
	41	11.49070.000	BOLT 6.20	1
	44	29.10596.136	PLUG, PIVOT PINE SWING ARM (D.30)	2
	45	15.14605.000	CLAMP	2
	47	13.17122.000	NUT M8	2
	48	11.55909.000	BOLT 8.55	2
	49	11.62050.000	BOLT 10.45 1,25(10.9)	2
	51	11.46251.000	BOLT 5,12	4



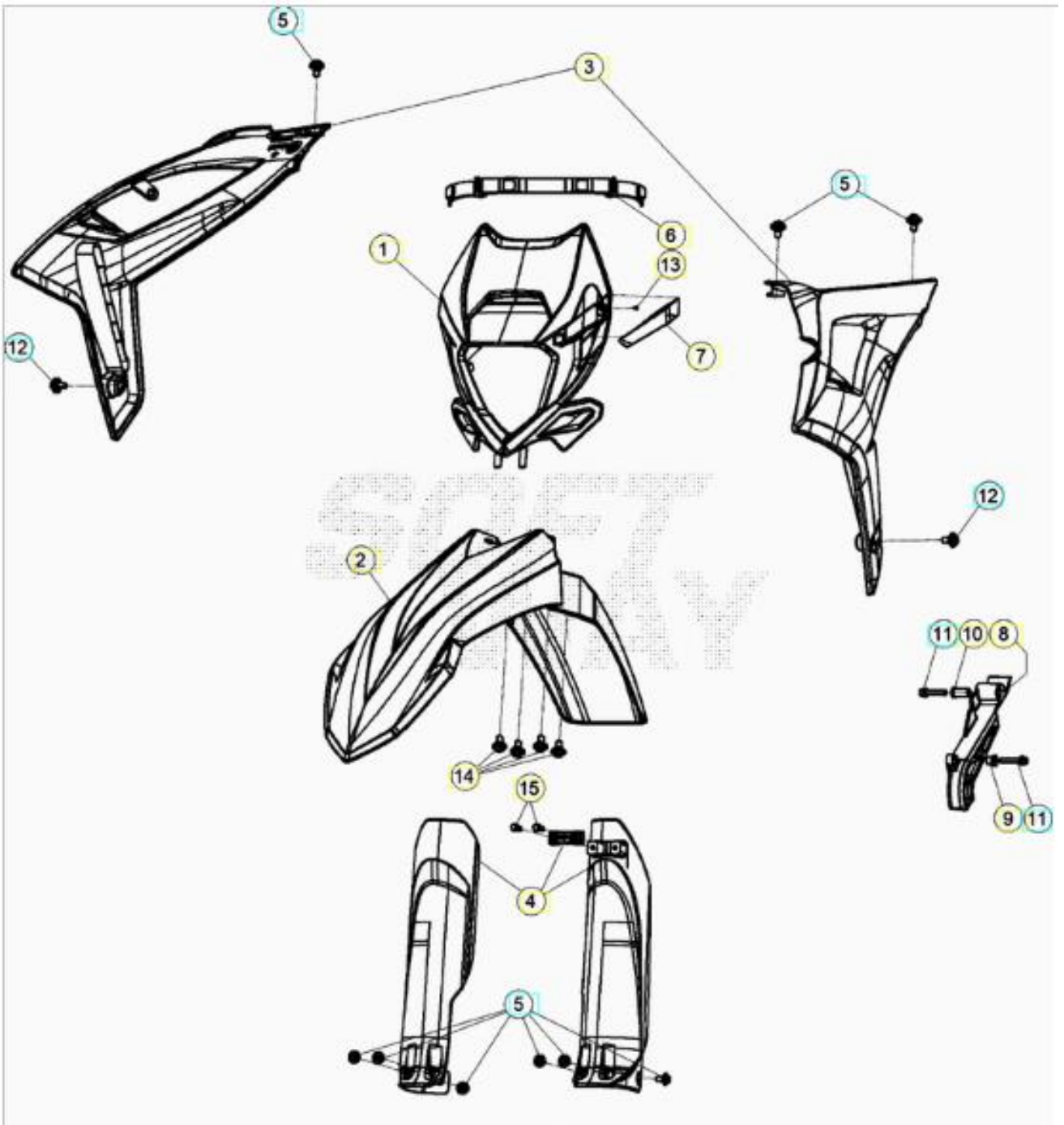

REF. NO.	PART NO.	MUDGUARDS DESCRIPTION	200 RR 2T
<input type="checkbox"/>	1	037.430080.051	HEADLIGHT MASK WHITE RR 1
<input type="checkbox"/>	2	037.430090.097	FRONT FENDER RED RR 1
<input type="checkbox"/>	3	037.430010.097	TANK PANEL . PAIR RED RR 1
<input type="checkbox"/>	4	026.451138.251	FORK GUARDS KIT, WHITE 1
<input type="checkbox"/>	5	037.430280.000	SPECIAL BOLT M6X8 3
<input type="checkbox"/>	6	037.430200.059	HEADLIGHT MASK RUBBER BAND 1
<input type="checkbox"/>	7	037.430170.051	FAIRLEAD WHITE RR 1
<input type="checkbox"/>	8	040.430050.059	PINION GUARD BLACK RR 2T 1
<input type="checkbox"/>	9	13.49190.000	SPACER 1
<input type="checkbox"/>	10	13.49189.000	SPACER 1
<input type="checkbox"/>	11	11.50300.000	BOLT 6.30 RS CH8 2

	12	037.430300.000	SPECIAL BOLT M6X16	2
	13	31.23580.000	PARKER SCREW 4,8.13	1
	14	037.430290.000	SPECIAL BOLT M6X12	1
	15	31.79960.000	SCREW, 6X15	1