



mod. BETA R-12

2008

24/04/08



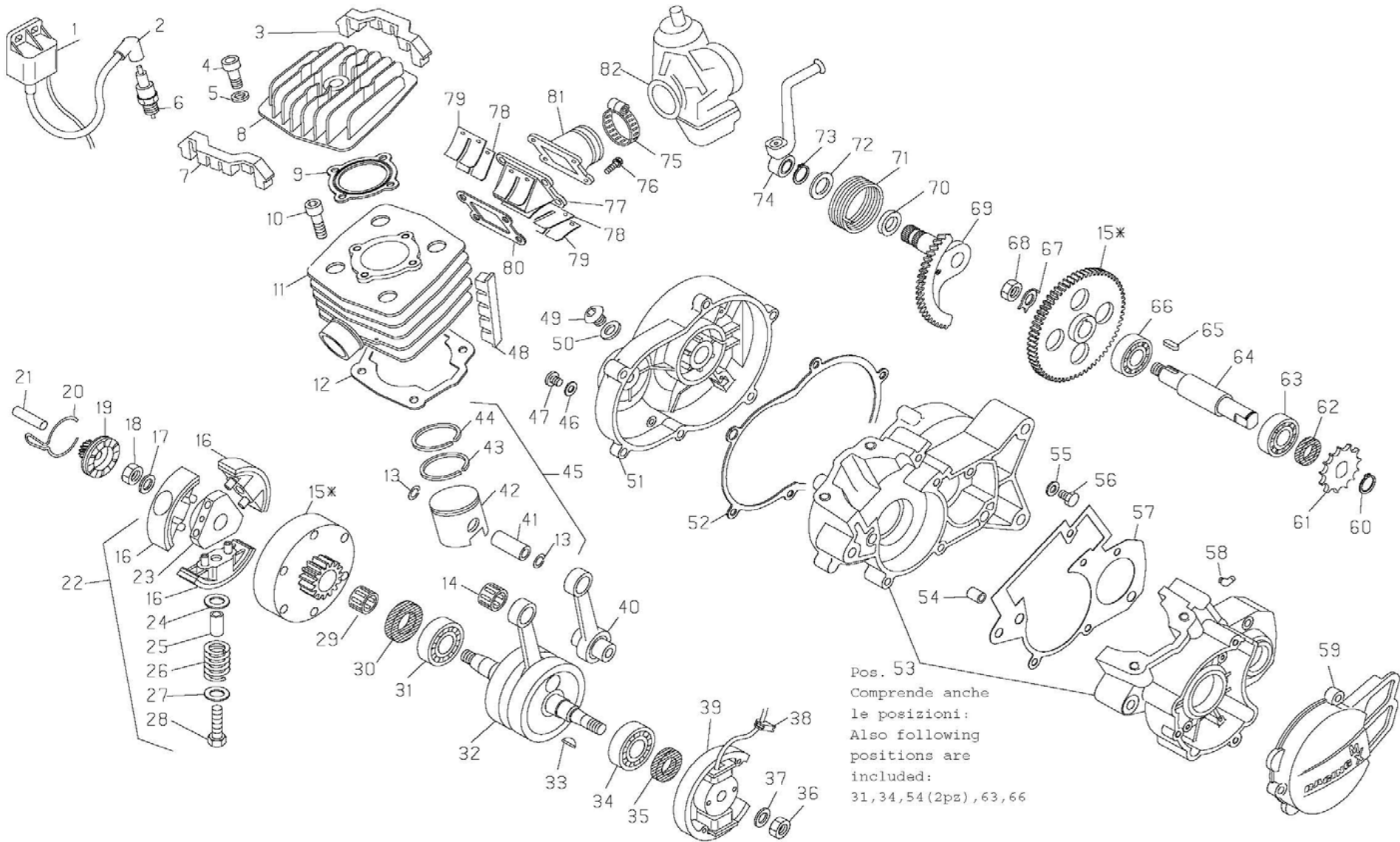



motore/engine R12 2008

Cod. 3742828 300
28/11/2007

N. POS.	CODICE NUMBER	DESCRIZIONE	DESCRIPTION
1	11-20631	BOBINA ATE	ELECTRONIC H.T. COIL
2	27-13512	RACCORDO CANDELA	SPARK PLUG PROTECTOR
3	16-21062	GOMMA ANTIVIBRAZIONI TESTA POST.	HEAD ANTIVIBRACTIONS RUBBER
4	31-45000	VITE TCCE M6X30	SCREW 6X30
5	27-40500	RONDELLA 6X13	WASHER 6X13
6	12-25200	CANDELA RN 3C SCHERMATA	SPARK PLUG 3N 3C
7	16-21061	GOMMA ANTIVIBRAZIONI TESTA ANT.	HEAD ANTIVIBRACTIONS RUBBER
8	29-12038-0-59	TESTA	CYLINDER HEAD
9	16-64100	GUARNIZIONE TESTA	GASKET
10	31-63890	VITE TCCE M8X20	SCREW 8X20
11	12-52501-0-59	CILINDRO	CYLINDER
12	16-61750	GUARNIZIONE CILINDRO-CARTER	CYLINDER CRANKCASE GASKET
13	10-42010	ANELLO FERMA SPINOTTO	CIRCLIP
14	16-11500	GABBIA 12X15X15	NEEDLE BEARING 12X15X15
15	29-06916-8	TRASMISSIONE PRIMARIA C/CAMPANA	PRIMARY DRIVE
16	22-30105-8	MASSETTA	CLUTCH PAD
17	27-58500-0-60	RONDELLA SPESS. 10X17	WASHER 10X17
18	13-20200	DADO SPEC. 10X1,25X6	SPECIAL NUT 10X1,25X6
19	22-14540	MANICOTTO MM	KICKSTARTER SLEEVE
20	22-58040	MOLLA MANICOTTO MM	SPRING
21	25-43911	PERNO 8X32	PIN 8X32
22	15-08876-8	FRIZIONE COMPLETA	CLUTCH ASSY
23	22-90019	MOZZO FRIZIONE	CLUTCH HUB
24	27-58061-0-50	RONDELLA SPESS. 8X15X0,50	SPECIAL WASHER 8X15X0,5
25	29-09577	TUBETTO PER MOLLA	SPACER
26	22-37890	MOLLA FRIZIONE	SPRING
27	27-58061-0-15	RONDELLA SPESS. 8X15X0,50	SPECIAL WASHER 8X15X0,5
28	11-49511	BULLONE 6X25	BOLT 6X25
29	16-12905	GABBIA 15X18X17	NEEDLE BEARING 15X18X17
30	10-62020	ANELLO PARAOLIO 17X35X7	OIL SEAL 17X35X7
31	12-96000	CUSCINETTO 17X40X12	BALL BEARING 17X40X12
32	10-00725	ALBERO MOTORE	CRANKSHAFT
33	12-45000	CHIAVETTA 2,5X3,7	WOODRUFF KEY 2.5X3.7
34	12-96000	CUSCINETTO 17X40X12	BALL BEARING 17X40X12
35	10-56010	ANELLO PARAOLIO 15X24X7	OIL SEAL 15X24X7
36	13-19020	DADO M10X1,25	SPECIAL NUT 10X1,25X6
37	27-58500-0-60	RONDELLA	WASHER
38	16-33510	GOMMINO PASSAFILI VOLANO	GROMMET
39	31-03262	VOLANO MAGNETE	ELECTRIC FLYWHEEL
40	11-03740-8	BIELLA COMPLETA	CONNECTING ROD ASSY
41	28-93610	SPINOTTO	PISTON PIN
42	25-80264	PISTONE D.39,5 PER GHISA	PISTON
43	28-60160	SEGMENTO	PISTON RING
44	28-60160	SEGMENTO	PISTON RING
45	25-03410-8	PISTONE COMPLETO D.39,5	COMPL. PISTON
46	16-47500	GUARNIZIONE 6X12X1,5	GASKET 6X12X1,5
47	31-30490-0-51	VITE M6X8	SCREW 6X8
48	16-21031	GOMMA ANTIVIBRAZ. CILINDRO	CYLINDER ANTIVIBR. RUBBER
49	29-10290	TAPPO OLIO	OIL PLUG
50	16-53600	GUARNIZIONE 16X22,5X1	GASKET 16X22,5X1
51	12-62113-0-33	COPERCHIO FRIZIONE	CLUTCH COVER
52	16-71530	GUARNIZIONE COPERCHIO FRIZIONE	CLUTCH COVER GASKET
53	12-06311-8	CARTER COMPLETO (pos.31,34,54(2pz),63,66)	CRANKCASE (pos.31,34,54(2pz),63,66)
54	16-36500	GRANO RIFERIMENTO CARTER 9X10	DOWEL 9X10
55	16-50510	GUARNIZIONE RAME 10X1,5X1	GASKET 10X15X1 COPPER

N. POS.	CODICE NUMBER	DESCRIZIONE	DESCRIPTION
56	11-58000	GOMMA ANTIVIBRAZ. CILINDRO	SPECIAL BOLT
57	16-55050	TAPPO OLIO	GRANKCASE GASKET
58	27-23380	GUARNIZIONE 16X22,5X1	BREATHER PIPE HOSE
59	12-70110-0-33	COPERCHIO VOLANO	MAGNETO COVER
60	28-23600	SEEGER 15E	SEEGER 15E
61	25-61110	PIGNONE CATENA Z.11	SPROCKET Z.11
62	10-54000	ANELLO PARAOLIO 15X24X5	OIL SEAL 15X24X5
63	12-94000	CUSCINETTO 15X35X11	BALL BEARING 15X35X11
64	10-26150	ALBERO RINVIO	TRANSMISSION SHAFT
65	12-46160	CHIAVETTA 5X5X12	WOODRUFF KEY 5X5X12
66	12-94000	CUSCINETTO 15X35X11	BALL BEARING 15X35X11
67	27-74760	RONDELLA FERMADADO ø14	SPECIAL WASHER D.14
68	13-28950	DADO M14X1,25	SPECIAL NUT 14X1,25
69	22-05084	MESSA IN MOTO	KICKSTARTER
70	10-56015	ANELLO PARAOLIO 16X22X4	OIL SEAL 16X22X4
71	22-79040	MOLLA RITORNO LEVA MESSA IN MOTO	KICKSTARTER SPRING
72	27-67510	RONDELLA 16X25X1	WASHER 16X25X1
73	28-23600	SEEGER 15E	SEEGER 15E
74	21-55112	LEVA MESSA IN MOTO	KICKSTARTER LEVER
75	15-15370	FASCETTA PER CARBURATORE	CLAMP
76	11-49070	BULLONE C/RONDELLA 6X20	BOLT 6X20
77	31-02140	VALVOLA ASPIRAZIONE COMPLETA	REED VALVE
78	21-15360	LAMELLA PER VALVOLA	VALVE'S BLADE
79	25-59670	PIASTRINA PER LAMELLA	VALVE'S PLATE
80	16-92550	GUARNIZIONE VALVOLA	VALVE' S GASKET
81	27-23051	RACCORDO CARBURATORE	INLET MANIFOLD
82	15-05075	CARBURATORE	CARBURETOR

PARTICOLARI NON FIGURANTI / SUPPLEMENTARY PARTS LIST

20-02854	KIT GOMME ANTIVIBRAZIONE	ANTIVIBRATION SET
28-06886-8	SERIE ANELLI PARAOLIO	OIL SEAT SET
28-08075-8	SERIE GUARNIZIONI	GASKET SET
25-03415-8	PISTONE COMPLETO D.40	COMPL. PISTON D.40
25-80267	PISTONE D.40 PER GHISA	PISTON
28-60171	SEGMENTO	PISTON RING
28-60171	SEGMENTO	PISTON RING

